

SSTT - Scandinavian Society for Trenchless Technology

Here, at the beginning of the 21st century, we can celebrate the silver jubilee of trenchless installation and rehabilitation methods. Numerous systems have been introduced over the years, nearly all of which have been put to use. Many of them are still employed today. Requirements for high quality and long service life leave no doubt about the suitability of the systems. However, the knowledge found in many large and small innovative companies has never been compiled, despite the fact that the methods are still being developed. No training is presently available on the systems currently in use and their applications despite continued development of the systems – systems that can also be expected to undergo tremendous future development in order to meet ever increasing demands for high-quality solutions and competitive prices. The widespread faults and shortcomings in the Scandinavian pipeline system will be remedied using the numerous existing systems, but will also benefit from the many technical innovations that the sector will continue to develop in the future.

More than ten years ago, Scandinavian collaboration on trenchless pipeline rehabilitation was begun. The Scandinavian Society for Trenchless Technology – SSTT – was established with the purpose not only of identifying and disseminating knowledge about techniques for trenchless renovation and installation systems but also of researching and developing new techniques.

It was therefore a particularly happy occasion when the board of The Scandinavian Society for Trenchless Technology (SSTT) unanimously agreed to grant a considerable sum of money in

support of the preparation of a handbook describing trenchless installation and rehabilitation techniques. Supplementary funding from various institutions, municipal authorities and contractors assured the financial basis for commencing the project: "SSTT – NO-DIG HANDBOOK". A great number of people from the Scandinavian countries have contributed to the handbook, as either authors or co-authors of sections on specific techniques. The editorial committee has also included representatives from SSTT member countries. The fact that SSTT is an exceptional cross-disciplinary forum has also made itself felt in so far as representatives of pipeline owners, manufacturers, consulting companies, and contractors have also contributed to the preparation of the handbook.

To ensure that the handbook is as technically complete as possible, a steering committee consisting of future users of the handbook was appointed to read and assess the material compiled. The purpose of the book was to gather all available knowledge and make it available to pipeline owners and the authorities responsible for maintaining the many run-down pipeline systems. A further purpose was to provide a reference book for use by the many people attending educational institutions and institutes that provide courses in the environmental aspects of the complex water pipeline and sewer networks.

As is evident from the above, many people have put considerable effort into preparing this SSTT NO-DIG HANDBOOK. All have provided their services without charge. The many authors who have contributed cannot be thanked enough for the admirable work they have performed.

Very many thanks to everyone who has assisted in this interesting project.



SSTT
SCANDINAVIA
MAY 2002

A handwritten signature in black ink, appearing to read "Gert Fischer".

Gert Fischer
chairman of
SSTT

A handwritten signature in blue ink, appearing to read "Bjørn Widman".

Bjørn Widman
chairman of the
Swedish working group

A handwritten signature in black ink, appearing to read "Lars H. Hagen".

Lars H. Hagen
chairman of the
Norwegian working group

A handwritten signature in blue ink, appearing to read "Lars Gaarn Jensen".

Lars Gaarn Jensen
chairman of the
Danish working group

2.1 The early years, 1980-1986

ISTT history goes back to the early 1980s, when several engineers in the UK began to question the efficiency of using conventional open-cut trenching for rehabilitating existing underground pipelines and for establishing new pipelines.

In a speech in 1980, one of these engineers, Ted Flaxman, drew attention to the inefficiency of conventional trenching methods and to the considerable disruption of traffic it caused. He also emphasised the significance of potential damage to infrastructure that resulted from digging up roads.

Later that year, a working group on trenchless technology was formed to assess alternative construction methods. At about the same time, an international survey highlighted pioneering work in the field of microtunnelling initiated in Japan and Germany and the use of trenchless methods to rehabilitate existing pipelines in the UK. It was clear that open-cut techniques produced similar problems in many parts of the world, and that alternative solutions were being actively investigated in several countries. The working group was therefore superseded in 1983 by an organising committee, whose purpose was to arrange a conference on trenchless technology to be held in 1985.

During the preparation of the conference, a suitable name for the new technology was discussed, and the term NO-DIG coined. The conference and associated exhibition were named NO-DIG '85 and were held in London in April 1985. Papers were presented at the conference from Australia, Japan, Germany, the USA and other countries. The conference – which was arranged by Westrade and attended by 67 companies and 385 delegates – was thus truly international.

One of the speakers at the conference was Dr Satoru Tohyama, the then vice president of Japan Sewage Works Agency. He was accompanied by a large delegation of contractors and plant manufacturers from the fast-growing microtunnelling sector. This proved to be the beginning of a long and fruitful partnership between ISTT and Dr Tohyama, who was awarded the ISTT gold medal in 1995 and was the president of the society from 1998 to 2001.

During the conference, the organising committee held several meetings in order to take advantage of the presence of experts from more than 25 countries. The success of the conference confirmed that an international organisation was needed to handle the exchange of information on

the new techniques, to organise future conferences and to establish a magazine that could communicate new technological developments. At the end of the conference, it was agreed to establish an international organisation.

On this background, the International Society for Trenchless Technology – ISTT – was founded on 8 September 1986 as a non-profit company under British law backed by 12 guarantors. Ted Flaxman and Peter Banks were appointed directors of the society, while John James and David Dacam were appointed technical secretary and secretary respectively. The society's magazine, published quarterly, was named *Underground*, and the first issue appeared in April 1987. It remained the official journal of the society until October 1993 when it was superseded by NO-DIG International.

2.2 International development and organisation, 1987 to the present day

During the following months, the newly appointed directors and staff promoted ISTT via their international network of contacts. One of the results was an agreement to hold NO-DIG '88 in Washington DC in collaboration with the US Water Pollution Control Federation.

In the meantime, a second international conference was held in 1987 – also in London – and was a great success. It hosted the first meeting of a new "International Committee" with representatives from the USA, Japan, Germany, the UK and the Netherlands. The second meeting of this committee was held at the NO-DIG '88 conference in Washington, which attracted a large number of participants from around the world, thus firmly establishing the society's credibility. At this conference, the establishment of the first national society in the Netherlands was announced.

As the activities of the ISTT grew, David Dacam was succeeded in November 1988 by John Sutro. At the same time, Ted Flaxman resigned from his consulting company in order to devote more time to the affairs of ISTT.

It soon became evident that a new structure was needed for ISTT – one that reflected the international status of the organisation to a greater extent. It was therefore decided that each national society should be invited to nominate a director to sit on the ISTT board, under the proviso that national societies became formally affiliated to ISTT and contributed to its funding.

The first meeting of the enlarged board of directors took place in Hamburg in October 1991 during NO-DIG '91. Nine representatives from seven countries participated, thus assuring the international status of ISTT. This global identity has since been reflected in the various nationalities of successive chairmen. Ted Flaxman was succeeded in October 1993 by Michel Mermet from France. Rolf Bielecki from Germany took over the chairmanship in March 1996, and was succeeded by Gert Fischer from Denmark in September 1999. The next change of chairman is due to take place in May 2002, when Ray Sterling from the USA will take over.

The custom of nominating vice presidents, started in 1987, has continued, and the positions are currently held by Menno Henneveld, chairman of the Australasian society and Dietrich Stein from Germany. Ted Flaxman has meanwhile continued his work for ISTT as chairman emeritus.

The day-to-day affairs of ISTT are managed by an executive secretary based in London. As the complete board – which currently has about 30 members – only meets once a year, an executive sub-committee – comprising the most recent former chairman, the present chairman, the coming chairman and one or two other members – meets quarterly to deal with the main questions on behalf of the full board.

The current executive secretary is John Castle, who succeeded John Sutro in 1998. He is assisted

by a secretary and by a part-time technical secretary, a position held by John Heavens since John James's retirement.

2.3 Affiliated societies (national organisations)

Right from the start, the initial organising committee was well aware that ISTT could not hope to be effective in promoting interest in the technology or arranging activities in individual countries where trenchless rehabilitation techniques were developing rapidly. The announcement in 1988 of the founding of the first national society in the Netherlands – with the twofold purpose of affiliating with ISTT and arranging a NO-DIG conference in Rotterdam in 1990 – was therefore welcomed. A Swedish society was established in 1989, and the year after, national societies were founded in France, Germany and North America.

The pattern of future ISTT development was thus formed. Companies and individuals in countries without a national society could initially join ISTT direct. Gradually, new national societies were then formed and affiliated with ISTT as local membership reached a viable size.

Annual subscriptions, based on the number of corporate and individual members, were introduced to provide funds to partially cover ISTT activities. In addition, day-to-day expenses are financed by income from the annual NO-DIG events and from the provision of various services.

Map showing national organisations affiliated with ISTT.

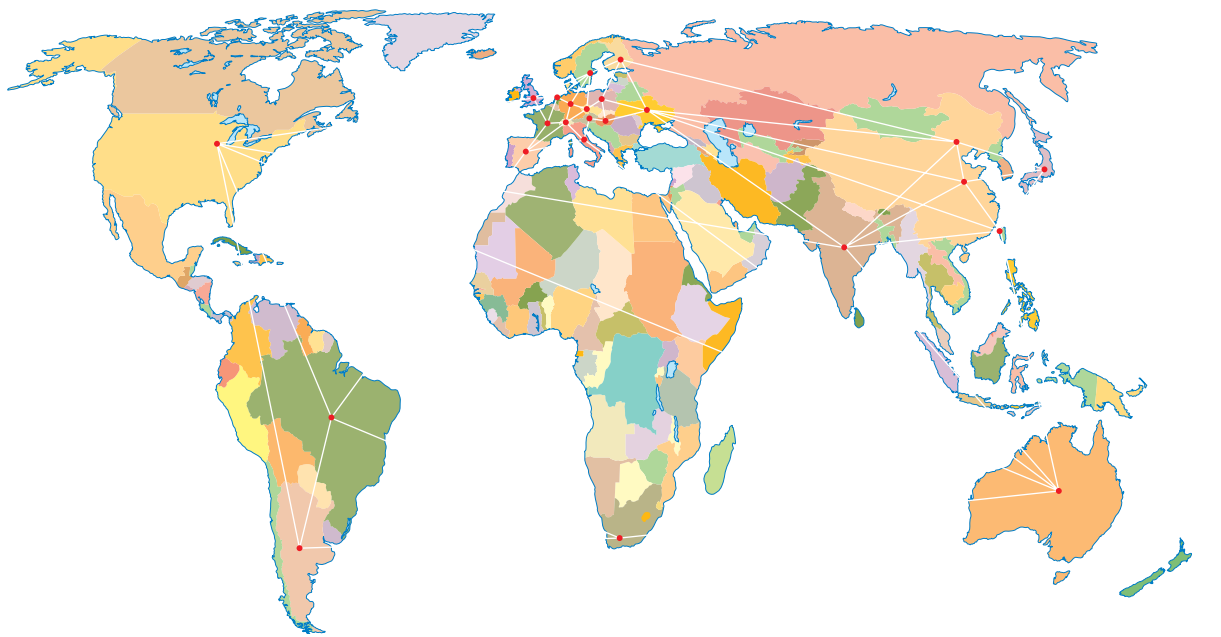

The number of ISTT members has grown steadily – from 1,280 in 1989 to 3,958 in 1999. Reorganisation of the North American and other societies in 1999 and 2000 has, however, reduced ISTT membership to about 3,500 as at 1 January 2002.

The larger national societies have set up web sites, organised annual conferences and exhibitions, and have permanent working groups on various technological aspects. The French and UK societies both hold "NO-DIG Live" events, in which trenchless techniques are demonstrated in practice. So far, 13 societies have arranged international NO-DIG conferences and exhibitions in collaboration with ISTT, and there is fierce competition among the societies to hold forthcoming events.

As at 1 January 2002, there were 25 affiliated societies altogether. For financial reasons, Russia and now also Argentina are not presently affiliated with ISTT, and the Hungarian society has but a single member.

2.4 International NO-DIG conferences and exhibitions

One of the main tasks of ISTT is to organise international NO-DIG conferences and exhibitions. Since 1987, these have been annual events, but two conferences were held in 1990, 1992 and 1997 to meet regional needs. In recent years, conference venues have alternated between countries with well-developed markets for trenchless technologies and countries with new, undeveloped markets. ISTT has deliberately targeted these latter countries in order to promote awareness of the advantages of NO-DIG techniques and to stimulate their implementation. Since 1990, conferences have been arranged as joint ventures between ISTT and the national society in question.

The main purpose of the conferences is to advance the science and practice of NO-DIG technology via the presentation and discussion of formal papers. Since 1985, over 700 papers from more than 1,200 authors have been presented at ISTT conferences. Conference proceedings – available in print until 1999, and since then available in electronic form – provide a unique record of the development of trenchless techniques and is an invaluable source of technical and market information. ISTT is currently considering ways of making this information easily available on its web site. As a start, topics covered at individual conferences will be listed.

The exhibitions associated with the conferences are an ideal opportunity for manufacturers and contractors to demonstrate their products and services to potential customers. Until now, more than 1,800 stands have been displayed. The exhibitions provide crucial funding for the conferences and also make considerable contributions to ISTT and national society funding.

At some of the conferences, work-sites have been set up locally so that delegates and other visitors could see for themselves full-scale NO-DIG techniques in practice. The best example of this is Copenhagen in 1994, where several fully operational work-sites could be visited over a three-day period.

The third, and probably most valuable, purpose of NO-DIG events is to provide a forum for informal discussions between manufacturers, contractors, consultants, customers and other interested parties from all over the world. This is particularly facilitated by the social events, reflecting local culture and traditions, that are held in connection with the conferences and exhibitions. Since 1985, more than 14,000 delegates have benefited from and enjoyed this unique opportunity.

Besides its own NO-DIG events, ISTT supports regional conferences and conferences on special topics. In 1995, ISTT arranged a conference in collaboration with the International Water Supply Association on lead pipelines as the culmination of work done by an ISTT working group on the subject. Also in 1995, ISTT sponsored a conference and exhibition in Warsaw on developments in Eastern and Central Europe. In 1995, ISTT provided financial support for Trenchless Asia, held in Singapore. A similar event will be held in Hong Kong in late 2002.

In February 2001, ISTT arranged Trenchless Egypt – the first NO-DIG conference to be held in the Middle East – in collaboration with the United Nations Environment Programme (UNEP) and Westrade. The conference consisted of two parallel sessions – one dealing with local issues and thus targeting local contractors and engineers, the other targeting invited governmental and public-amenity decision-makers in order to communicate information and training on the environmental benefits of NO-DIG methods for the installation of new supply pipelines and the maintenance of existing pipelines. Cooperation between ISTT and the UN will be continued and expanded in the coming years.

Besides marketing via the international NO-DIG conferences, ISTT has also used various

publications and, more recently, the Internet to spread information on NO-DIG techniques and their advantages. ISTT publications include "Glossary of Trenchless Terms", a dictionary of NO-DIG terminology, and "Trenchless Guidelines", a comprehensive overview of the possibilities for pipeline rehabilitation using NO-DIG methods that includes information on a broad spectrum of topics ranging from pipeline inspection and assessment to choice of suitable technologies for evaluating final results.

"Trenchless Guidelines" is marketed by ISTT, but members also have access to download the booklet in pdf format from the ISTT web site. Several national societies have translated the guidelines into their own languages.

In addition, an ISTT Directory and Yearbook is published, which allows potential users to locate and contact manufacturers, suppliers and contractors offering the entire range of NO-DIG services. This and many other facilities are now available on the ISTT web site (www.ISTT.com), which has recently been completely updated and redesigned in order to meet the needs of members. ISTT also collaborates with Elsevier on the publication of the journal "Trenchless Technology Research", which contains peer-reviewed papers on a wide range of relevant topics.

The final element in ISTT dissemination of information is the official society magazine – initially called Underground, since 1993 called NO-DIG International (NDI). The journal, now published monthly, is sent to all members of ISTT and affiliated national societies as part of their membership. Technical and market-related articles on all aspects of NO-DIG technology are published in NDI.

2.5 NO-DIG awards

Since 1986, ISTT has given an annual award to organisations and companies that have made exceptional contributions to the promotion of NO-DIG methods. The award is presented at the annual international NO-DIG conferences and the awarding jury consists of ISTT board members, that is to say representatives of the individual national organisations.

2.6 ISTT in the future

Since 1995, the work of ISTT has been based on a strategy and plan of action adopted at the conference in Copenhagen in 1994. This plan expired in 2001, and the ISTT board adopted a new plan of action for the period 2001 to 2005 at its meeting in Perth, Australia. The plan, which to a great extent focuses on the needs and requirements of members, sets goals for the coming years and describes means of attaining them. ISTT plans to publicise the plan of action on its web site.

3.1 Planning water pipeline rehabilitation

The objective of water companies is to ensure that customers always have access to supplies of clean drinking water. There must be a high security of supply, and water must be provided by environmentally sound means. Rational planning of pipeline rehabilitation is of the utmost importance if water companies are to fulfil their objective.

It is impossible to set out general guidelines for the rehabilitation requirements of individual water companies as requirements will depend on local conditions, including the age of the pipeline system, the material the pipes are made of, the pressure in the pipeline and the characteristics of the ground in which they are buried. It is therefore necessary for each water company to investigate its own specific rehabilitation requirements to facilitate long-term planning of the often considerable investments involved in rehabilitation.

Traditionally, rehabilitation planning is to a great extent based on information about fractured pipes, and the number of fractures registered through time for individual pipeline sections has been used as a measure of their condition.

Detailed planning of pipeline rehabilitation is, however, a dynamic process that is not merely a question of the number of leaks. Determining when individual pipelines should be rehabilitated depends on a wide range of constantly changing factors. The most important factors in rehabilitation planning are as follows:

- Consumers, surroundings and social costs
- Economic aspects
- Pipeline condition
- Operational aspects

Within each of these areas, various criteria can be defined for selecting pipelines that require rehabilitating.

Consumers, surroundings and social costs

Insufficient pressure, unsatisfactory security of supply or poor water quality can be contributing reasons for initiating pipeline rehabilitation work. Pipelines that supply many customers or supply companies consuming large quantities of water should be rehabilitated before less-used pipelines. Pipelines situated where fractures cause inconvenience – under busy roads or pedestrian precincts for example – should be rehabilitated before pipelines in less critical locations.



Discussing the choice of rehabilitation method.

Economic aspects

Economies can often be achieved by co-ordinating rehabilitation with other pipeline work and road repair. Such benefits should be taken into account when planning pipeline rehabilitation. Similarly, rehabilitating several pipelines in the same area will often provide savings in comparison with rehabilitating isolated pipelines

Pipeline condition

As previously mentioned, data on the recorded number of fractures in individual stretches of pipeline has traditionally been used as the main criterion for commencing rehabilitation work. However, the age of the pipeline system and the material the pipes are made of can also be important factors in rehabilitation planning.

Operational aspects

Pipelines whose location makes leak repair unusually difficult should be prioritised when planning rehabilitation work. Examples of such pipelines are those that are inaccessible because of their proximity to other pipelines and cables, and pipelines that can only be rehabilitated at night because of traffic.

Rehabilitation plans should be based on relevant data on the pipeline system and other aspects. Data from the following sources can be used in planning:

- Results of water-loss and leakage investigations
- Pipeline data
- Pipeline analysis and engineering calculations
- Pipeline databases
- Other pipeline owners' plans for rehabilitation and installation
- Road maintenance authority plans for road surfacing
- Water requirement projections
- Water supply plans
- Municipal authority plans
- Consumer complaints

Once all relevant data has been collected, the data and reports must be systemised in order to obtain an overview of where there is a pressing need for rehabilitation.

In 1995, the Danish Water Supply Association (Danske Vandværkers Forening) published guidelines on rehabilitation planning, and a European planning tool, CAREW (Computer Aided Rehabilitation of Water Networks) is currently being developed.

Finally, it should be mentioned that technologies are currently available that make it possible to measure the remaining thickness of metal pipelines, including those made of cast iron, during internal inspection. An ongoing project in Norway is based on Resonance Thickness Measurement (RTM) technology.

3.2 Choice of method for pipeline rehabilitation

Selecting an appropriate NO-DIG method should be based on the stated pipeline function requirements and an assessment of the technical aspects of the rehabilitation work to be performed.

When comparing alternative methods of trenchless pipeline rehabilitation the following factors should be assessed:

- Future use of existing pipeline
- Reduction of cross section area
- Intersecting pipelines
- Necessary preconditioning
- Advance rates
- Costs

Pipeline function requirements

It is fundamental that the pipeline function requirements be known.

The following pipeline types might be involved:

- Pipelines for unfiltered water at the water intake plant
- Transport lines for unfiltered or filtered water
- Water mains
- Supply lines
- Service lines

Pipeline type is important in determining the extent of temporary supply and re-routing required during pipeline rehabilitation.

Requirements for pipeline capacity and pressure drop must be determined, and, on the basis of these values, a hydraulic analysis carried out. To ensure satisfactory future performance, it is imperative that hydraulic characteristics are thoroughly investigated in order to ensure that the pipeline is dimensioned correctly and functions satisfactorily under all operating conditions. The pipeline must have sufficient capacity and pressure drop for the maximum amount of water, and at the same time must not have unnecessarily low flow rates with the accompanying risk of long holding times for the water in the pipeline under normal operating conditions. In light of the general reduction in water use over recent years, smaller pipeline diameters will often be a possibility or even a necessity to prevent insufficient water renewal in the pipeline. This means that several NO-DIG methods may be relevant.

On the basis of the hydraulic analysis – supplemented in the case of transport pipelines with a pressure-surge analysis – the maximum operating pressure is determined for the pipeline, and thus also the future pressure class. As the internal diameter of PE pipes varies with pressure class, it has of course been necessary to choose a pressure class for the initial hydraulic analysis. If the pipeline pressure class is subsequently changed, it becomes necessary to repeat the engineering calculations.

Technical aspects

Knowledge of the conditions under which rehabilitation work will be performed is of great importance for the choice of method.

It is imperative that the material the existing pipes are made of and the number and type of fittings (service line connectors, valves, fire hydrants, repair sleeves, etc.) be known.

It is important to know the length of the various pipeline runs that can be rehabilitated without intermediate excavations. In this respect, the number and location of service lines needs to be known, and stop valves, venting valves and

bends (including the angle taken) must also be localised. Normally, excavation of all these will be necessary, irrespective of which NO-DIG method is chosen.

Other things being equal, the depth at which the existing pipeline is laid is important because the cost of necessary excavation work will rise with increasing depth. Methods with long rehabilitation runs that require a minimum of excavation will therefore be more advantageous.

Other technical aspects that may be of importance are the condition of the foundations of the existing pipeline and the characteristics of the surrounding soil. Is the soil easy to excavate? How deep is the water table? What are the water-bearing characteristics of the soil? If, for example, the pipeline has pile foundations, methods that remove the load-bearing capacity of the existing pipeline (e.g. pipe bursting) will normally be unsuitable.

Surface and traffic conditions over the stretch of pipeline to be rehabilitated should be included in the assessment of the conditions under which restoration is to be carried out. Is the pipeline located in a rural area, an area with single-family detached houses, or in a built-up area? Are there main roads with particularly hard surfaces in the area?

The water supply to consumers must be assured during the entire period of pipeline rehabilitation by providing temporary supply lines or temporary re-routing. Such provisions are often expensive. Temporary supply will always be necessary when service lines or supply lines are to be rehabilitated. If main supply lines are also to be rehabilitated, work on these lines will often be possible without temporary re-routing when the lines are part of the distribution network of a large water supply system. If on the other hand main supply lines of a smaller supply system are to be rehabilitated, temporary re-routing will often be necessary.

All NO-DIG methods require that rehabilitated pipelines can be cleaned and flushed. Several NO-DIG methods also require that deposits in the existing pipeline be removed before new pipe is inserted. In some geographical areas, the classification of watercourses in the vicinity of pipelines may impose severe restrictions on the discharge of flushing water into such recipients, thus limiting the possibility for pipeline cleaning and flushing. All aspects of cleaning and flushing should therefore be included in rehabilitation planning.

Economic aspects

Economic aspects will often greatly influence the choice of rehabilitation method. A complete analysis of installation and operating costs should be made. Sliplining is generally the cheapest rehabilitation method, but its use involves a reduction of pipeline cross-section area by 25-50%. With unaltered water quantities, this will increase flow rates by 33-100% and thus produce considerably higher pressure drop and corresponding increase in operating costs. In each and every case, the required quantity of water must therefore be determined as precisely as possible, so that reliable hydraulic analyses and realistic estimates of installation and operating costs can be made.

Establishing launch and reception pits for laying new pipelines is expensive, especially in built-up areas with road surfaces designed for heavy traffic. In these situations, methods requiring few and small excavations will normally appear attractive from an economic point of view. An additional advantage of such methods is that they are less of an inconvenience for traffic and local residents. The extent of road digging and the amount of soil to be stored, and possibly also disposed of, is also reduced, thus providing positive environmental effects in the form of reduced noise, reduced air pollution and reduced consumption of sand, gravel, etc. If, however, several pipeline owners and road authorities join forces in a co-ordinated rehabilitation project, the above argumentation may be less relevant to the choice of rehabilitation method.

The construction costs of the various NO-DIG methods cannot be considered in isolation, but must be assessed in relation to the installation conditions under which the work is to be carried out. It is therefore difficult to determine whether any one method has economic advantages over others.

Social costs

Many aspects of rehabilitation work are important while the project is underway, but have no influence on the operation of the finished pipeline. Among these are so-called social costs. The above-mentioned disruption of traffic, and the inconvenience caused by excavation, noise and air pollution may have direct economic consequences, such as lower turnover in surrounding shops, and may also have indirect costs in the form of extended journey time due to long-term traffic disruption. The same factors have social consequences for the everyday life of local residents, shopkee-

pers and other people working in the affected areas as well as for the customers of local shops and businesses. All these will people experience daily inconvenience with respect to parking, access, noise, etc. that may pose health risks and reduce the quality of life.

The choice of method for pipeline rehabilitation will thus often affect society at large in addition to having operational and economic effects. The various methods do not, however, produce the same effects in all areas. On the contrary, it will often be necessary to weigh technical, economic and social aspects against one another, and choose the most appropriate solution on the basis of an overall assessment.

Service line rehabilitation

The pipes connecting plumbing fixtures within a building to the water mains are known as service lines.

Government regulations distinguish between service lines on public property and those on private property where the property boundary is a pavement or public right-of-way.

3.3 Legislation on service lines

Danish legislation

The Danish Environmental Protection Agency's Standard Regulations for Private Water Companies, 1996 (Normalregulativ for private vandforsyninger) and Standard Regulations for Municipal Water Companies, 1981 (Normalregulativ for kommunale vandforsyninger) agree on the question of who owns and maintains service lines on public and private property.

Regarding service lines with possible stop cocks on public property, standard regulations stipulate the following:

- Service lines shall be installed, owned, and maintained by the water company
- Service lines shall be installed by qualified plumbers or water company employees
- Separate service lines shall usually be established to supply each property
- Service lines shall usually be connected to the water mains in the road or street onto which the property faces, i.e. is accessed from
- Service lines may in special circumstances supply two or more properties. In such cases, supply conditions shall be described in a covenant approved by the water company and registered in the deeds for the properties involved

- The property owners shall meet the costs of preparing and registering said covenant
- If service lines pass through private property, the right to install, use and maintain these shall be assured in a covenant registered in the deeds for the property or properties involved
- The water company may re-lay service lines if a property is parcelled out, if there are substantial changes in water consumption or if rebuilding or conversion work is carried out that requires service line re-routing. In such cases, the property owner shall be liable to pay the costs of re-laying. The property owner shall also be liable to pay re-laying costs if the owner himself/herself requires the relocation of service lines
- The water company may disconnect at the mains service lines supplying properties that are not presently used. The property owner shall be liable to pay the costs incurred
- The property owners shall immediately and forthwith inform the water company of actual or suspected faults, including leaks in service lines and stop cocks
- The user of a water supply shall inform the property owner of any faults at the earliest possible date

Regarding service lines on private property, standard regulations stipulate the following:

- Service lines shall be owned, installed and maintained by the property owner
- Service lines shall be defined as underground water pipes
- Work on service lines may only be carried out by qualified plumbers or water company employees
- The water company may demand that service lines be re-laid when a building is converted if this is deemed necessary to ensure future water supply to the building
- Meter wells shall be constructed in such a way as to keep the meter frost free and to provide the well with a sturdy cover
- The property owner shall be responsible for ensuring that detected or suspected leaks in service lines are investigated and repaired as required as soon as possible
- The water company may demand that property owners instigate the necessary service line repairs at the property owner's expense if the water company suspects that there are leaks in the service line

- Any person having a contractual right to use a service line shall inform the property owner of any detected or suspected faults as soon as possible
- A local authority may at the request of a water company see to it that the necessary work on a service line is performed at the expense of property owners if they neglect the responsibilities placed upon him/her by the afore-mentioned stipulations

Many water companies, however, still use regulations that differ from these standard regulations. For example, some water companies have elected to retain responsibility for service lines beyond the boundary of private properties as far as the shut-off valve located one metre within the property. If there is doubt about local practices, ownership, etc., it is advisable to obtain a statement from the water company in question.

Norwegian legislation

The VA network in Norway is divided between private and public ownership at the lateral connection point. In other words, the lateral (i.e. the pipeline system between the main sewer connection and the building it serves) is owned by the individual subscriber. Property owners therefore have full responsibility for ensuring that the system functions correctly and are fully liable for any situations arising from faults, etc. in the privately owned system.

Work on the privately owned part of the network is regulated by: Water Resources Act

- Planning and Building Act (PBL) of 28.06.1996 (latest amendment)
- Various directives under the Planning and Building Act, including the approval catalogue prepared by the National Office of Building Technology and Administration (Statens bygningstekniske etat)
- “Ren veiledning til teknisk forskrift til plan- og bygningsloven”, published in 1997 by the National Office of Building Technology and Administration
- Standard regulations for sanitary installations
- Local authority sanitation regulations
- The Norwegian Standards Association (Norges standardiseringsforbund)



Renovating water pipes close to the foundations of a building

3.4 Planning service line rehabilitation

Traditional open-trench methods are normally used to install service lines for new buildings on virgin soil.

It is, however, beneficial to use NO-DIG methods when it is necessary to take account of existing streets, buildings and pipeline systems, when installing service lines for new buildings in built-up areas – on former industrial estates, for example – or when single sites are being developed on existing streets (hole filling).

Nowadays, service lines on public and private property are, wherever possible, almost always replaced using NO-DIG methods.

In older areas of towns, where buildings open directly onto pavements or pedestrian precincts, traditional excavation from the water mains to the

Renovating water pipes in a residential area.



foundations of buildings will be most suitable on the side of the road on which the mains is located.

Service line replacement is usually carried out as part of a complete rehabilitation of the supply line network.

Service lines on private property account for a high proportion of the water loss through leakage suffered by water companies. It is therefore important to replace those service lines that from the point of view of age or the material they are made of are not on a par with the rehabilitated part of the supply line network. It is in the interest of water companies to replace as many service lines on private property as possible as they are physically integrated parts of the water supply system. Information about the condition of service lines on private property is often lacking, especially for those supplying old buildings.

As previously mentioned, the costs of replacing service lines on private property must be covered by the property owners. Water companies can only demand replacement if it can be proved that the lines leak. However, replacement of more than 80% of service lines on private property can be achieved by providing property owners with targeted information and possibly also subsidies. An example of a letter providing information to property owners is shown below.

It may be advantageous to have local plumbers follow up on this information material by sending out specific quotations after the work required has been advertised.

If service lines must be replaced because of leaks or encrustation causing reduced hydraulic capacity, the water company determines the dimensions, pipe material and connection method to be used.

Danish design criteria

According to Danish plumbing standards (Norm for vandinstallation, DS 439), pipes with a diameter of less than 32 mm should not be used.

Pressure drop can be read off a diagram, but a sufficiently accurate result can normally also be achieved by using a simple formula based on the design flow rate per building of 1.6 litres per second.

The available pressure, P_{avail} , to overcome pressure drop in the service line must be greater than or equal to 0.05 m of water gauge per metre pipe.

In water company circles, supply pressure is commonly expressed in metres of water gauge

(m wg) instead of Pa, the usual SI unit, because results are easier to evaluate (pressure in metres of water gauge above the ground, or pressure contour in metres of water gauge above Danish Ordnance Datum (Danske Normal Nul)).

Usually, polyethylene (PE) pipes with diameters of 32, 40 or 50 mm are used. Where there is a risk of hydrocarbons or chlorinated solvents seeping through the soil, diffusion-resistant, metal clad PE pipes should be used.

If the service line is also to be used to trace hydrocarbon leaks at garages and petrol stations, low-diffusion PEL pipes should be used.

3.5 Choice of method for the rehabilitation of service lines

Two soil displacement methods are available: directional drilling and impact moling.

Directional drilling is characterised by the use of drilling fluid and by the drilling equipment requiring more space in the excavated launch pit or building basement. The rectangular pit is positioned lengthways across the road, but cables running across the pit may make manoeuvring and fitting drill rods difficult.

The use of pressurised drilling fluid can cause unintended ground upheaval if the drill head runs into heterogeneous, porous soil layers. The method is, by definition, steerable, and is most suitable for installing long service lines.

Impact moling can be carried out from excavated pits or from building basements. The met-

Pre-bored hole in basement for inserting an impact mole.





A typical example of impact moling from a basement.

hod does not require as much space as directional drilling because the compressor and other equipment are located outside the pit or basement.

When installing a service line from a basement, a hole in the outside wall of the basement should be bored through which the moling head can be inserted.

The method is non-steerable, and the direction taken changes frequently when the moling head meets heterogeneous soil layers, rocks, foreign bodies, etc.

3.6 Leak detection

Background

To accomplish optimum operation of water intake plants, water treatment facilities and pipeline systems, it is important that water companies monitor and control the quantity of water lost.

Water loss affects water company profitability and the surrounding environment, and may have consequences for supply reliability and compliance with safety regulations.

The economic consequences of water loss include increased costs in connection with:

- Water intake plant operation
- Water treatment plant operation
- Water transport
- Danish duties (if the loss exceeds 10%)

In addition, pipeline owners may be held liable for damage to third party property caused by water leaking from pipelines. A Danish Supreme Court ruling from 18 August 1983 imposes this strict liability on pipeline owners. Further information on the case and the liability of water companies to pay damages is available in training book no. XXXIII 1984 (see references) issued by the Danish Water Technology Association (Dansk Vandteknisk Forening).

The ruling gives the following grounds for the strict liability: "Damage caused by fractures occurring in the stated way are deemed to be a cost of supplying water that should be met by the

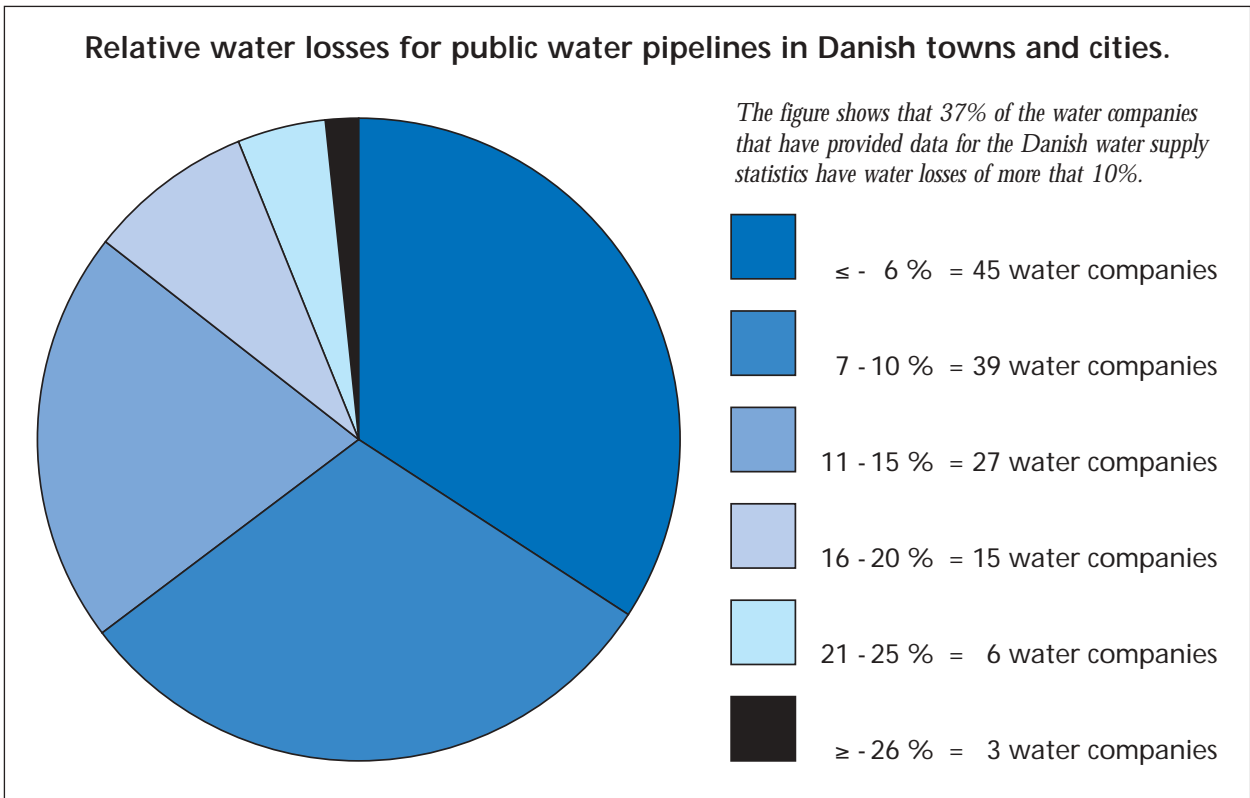

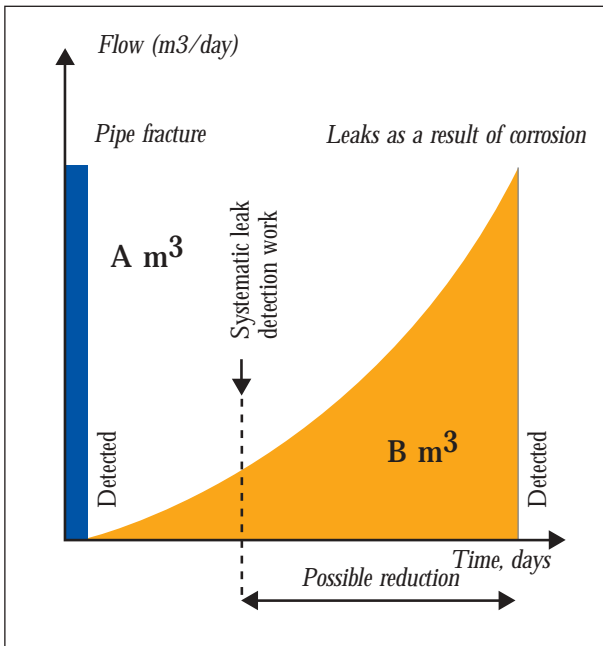

The diagram shows that spontaneous pipe fracture – area A – results in considerable water loss, but is quickly detected and repaired. Most water is lost from pipeline networks through insidious leaks resulting from corrosion – area B. Such leaks develop over a number of years, and the water losses they cause can be reduced by systematic leak detection.

owners of the particular water company and associated pipeline system, who have the opportunity of taking the risk of such predictable events into consideration in the technical and economic planning of pipeline operation".

Extensive, uncontrolled water loss can also result in premature or unnecessary investment in expanding the capacity of:

- Water intake plant
- Water treatment plant
- Water distribution networks ("bottlenecks")
- Pumping stations

For these reasons it is important to keep pipeline condition under control. This includes inspection for insidious leaks, i.e. leaks that have yet to make their presence felt on the surface but grow bigger and bigger through time.

With respect to the consequences for supply reliability, it should be kept in mind that considerable water loss is usually the result of faults in the pipeline system that may lead to insufficient pressure ("bottlenecks").

Leaking water can also cause injury to persons and damage to property. In addition, pipeline

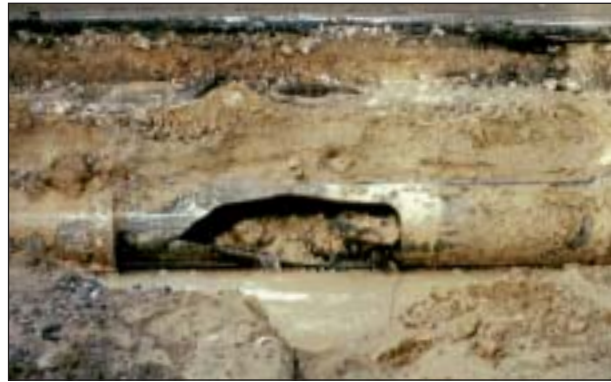

A spontaneously fractured 610 mm cast iron pipe which resulted in a calculated water loss of 10,000 m³.

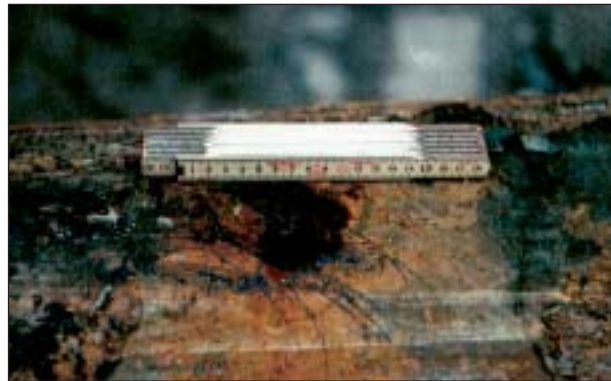

A leak in a ductile cast iron pipe developed over a number of years as the result of corrosion. Calculated annual water loss of 375,000 m³.

leaks may under adverse conditions result in water being sucked back into the pipeline thus impairing water quality.

Last but not least, it would – in the light of campaigns designed to increase consumer awareness on the issue of saving water – be fitting if individual water companies put their own house in order and achieved acceptable levels of water loss before asking consumers to use drinking water with care and economise on its use wherever possible.

Legislation in Denmark

In recent years, there has been increased interest in water loss, especially in companies experiencing water losses in excess of 10%.

Interest in water loss has been stimulated particularly by Consolidated Act no. 6756 dated 13 July 1994 issued by the Danish Ministry of Taxation

concerning duties on pipeline supplied water (Bekendtgørelse af lov om afgift af ledningsført vand (see references).

The Act stipulates that public water companies with a water loss higher than 10% shall pay a duty to the state – currently 5 DKK/m³ excl.VAT – for the part of the quantity of water exceeding 10%.

According to Water Supply Statistics for 1999 (Vandforsyningsstatistik 1999 (see references)) published by the Danish Water Supply Association, approx. 25% of the water companies which stated their water loss as a percentage had to pay "penal" duties to the Danish state. The amount of these duties varied from about DKK 4,500 to just about DKK 1 million!

Water loss

Total water loss, which is the difference between the water quantity pumped and the water quantity

invoiced, can be divided into:

- "genuine" water loss, which results from leaks in the pipeline system between metered source and metered consumption, and
- "false" water loss, which mainly consists of water consumption that is not metered or is metered incorrectly

The way in which genuine and false water loss form part of the total "pumped water balance" can be seen in the table below.

The data from a Swedish investigation shown overleaf gives an impression of the relative importance of the various types of water loss.

Where it is not possible to segregate the total quantity of lost water into its component parts as in the Swedish investigation, but where the total quantity of lost water is known, a simple rule-of-thumb predicts that about 75% of the total water loss will be genuine water loss.

Pumped water quantity	Authorised consumption	Invoiced authorised consumption	Invoiced metered consumption (incl. exported water)	Income from water consumption
			Invoiced unmetered consumption	
	Total water loss	False water loss	Non-invoiced authorised consumption	No income from water consumption
			Non-invoiced metered consumption	
	Genuine water loss	Genuine water loss	Unauthorised consumption	No income from water consumption
			Metering inaccuracy, drip loss, etc.	
Leaks in the pipeline system				
		Leaks and overflow from tanks and towers		
		Leakage in service lines on private property		

Water loss	Min. %	Max. %	Comments
Leaks in the pipeline system	6	16	Genuine water loss
Pipeline flushing	0.2	2	False water loss
Sewer flushing	0.1	1	False water loss
Fire fighting	0.05	0.1	False water loss
Pipe bleeding to prevent frost damage	0	1	False water loss
Unmetered consumption by contractors	0.2	0.5	False water loss
Inaccurate water meters	Plus/minus 1	Plus/minus 2	False water loss
Total	8	23	

Data from the Danish Water Supply Statistics for 1999 (see references) shows considerable variation in both the relative and total specific water loss:

Genuine water loss

This section deals with genuine water loss. Genuine water loss results from the following:

- Pipe fractures
- Leaking pipe connections
- Leaking components (valves, venting valves, fire hydrants, etc.)
- Leaking water towers and elevated tanks

	Min.-max.	Min.-max.	Comments
Water loss	% 0.9 - 37	m ³ /km/år 17 - 2577	Total water loss

Water pressure can affect the amount of genuine water loss – the higher the pressure, the greater the loss. In order to minimise genuine water loss, operating pressure in plant, pipelines, etc. should not be higher than that necessary to provide consumers with a satisfactory water supply.

As prevention is better than cure, the following factors should be taken into account during planning, installation and operation:

- Quality assurance of incoming materials (check for transport damage, etc.)

- Quality assurance of excavation work and pipe laying (foundation laying, pipe laying, ability to withstand the weight of traffic, etc.)
- Pressure surges in connection with pump operation as well as pipeline work, filling and emptying, and valve operation

It is worthwhile to prepare guidelines for these factors to provide a tool that can help minimise genuine water loss.

Leakage

Considerable quantities of water can be lost through leakage, as illustrated by the examples in the following table:

Methods to reduce water loss through leakage

Water loss from leaks can be considerably reduced at relatively little cost if the work is rationally planned and performed.

This is also borne out by the rule-of-thumb stating that 20% of all leaks cause 80% of all water losses.

Rational, systematic monitoring and inspection of the pipeline system can be carried out in the ways listed below and described in the following sections:

Nominal diameter (mm)	Material	Fracture type	Pressure m wg	Water loss m ³ /h
100 mm	Grey cast iron	Cracked all the way round - crack width 1mm	30	ca. 17
		5 mm hole caused by corrosion	30	ca. 1
		10 mm hole caused by corrosion	30	ca. 4

- Continuous monitoring of hourly night-time consumption
- Overall monitoring of minimum night-time consumption
- Measurement of minimum night-time consumption in specific areas
- Water loss measurement in predetermined areas
- Leak noise correlation and acoustic listening systems
- Continuous monitoring
- Re-checking

Continuous monitoring of hourly night-time consumption

In less complex systems – e.g. where a "fixed" night-time capacity is provided by filling a single elevated tank or water tower – the slope of the curve drawn by the water level meter indicates whether there are problems. If the curve is flatter than usual, the reason may be leakage in the pipeline system.

In more complex systems with several water-works and elevated tanks, assessment of night-time consumption must include data on current water production rates and storage in tanks and towers. The necessary data may be available from the control, regulation and monitoring system, but more accurate measurement of tank water level may also be required. Measurements should be taken at predetermined intervals (e.g. on fixed weeks each year).

Overall monitoring of minimum night-time consumption

Overall monitoring of the water level measured in elevated tanks and water towers can also be performed within one or more pressure zones. The pumps filling the tanks and towers with water should be stopped and the fall in water level through time measured using precision measuring instruments. Measurements should be taken between 2 and 4 a.m. when night-time consumption is usually at a minimum.

If these measurements differ from "normal" night-time consumption (see later), there may be leaks in the pipeline system. If normal night-time consumption is not constant because industrial companies, hospitals and others customers consume large quantities of water, such consumption must be known – possibly by the remote transfer of consumption data. As an alternative to water level meters, elevated tanks and water towers can be metered.

Measurement of minimum nighttime consumption in specific areas

A more detailed monitoring of night-time consumption can be performed by dividing the supply area into sections supplied by individual elevated tanks or water towers.

Water consumption from the tank is measured after closing the valves in the area supplied by the tank. The person recording consumption should also dictate (via walkie-talkie or mobile phone) when the valves are to be shut off.

Similar measurements can be made via chambers located at strategic points on the pipeline. Measuring equipment can be permanently or periodically installed in the chambers in order to record consumption in specific areas. Based on the results, it can be assessed whether there are areas where more detailed investigations in the form of flow measurement, leak noise correlation or acoustic leak detection are necessary.

Water loss measurement in predetermined areas

"Zero consumption" can be measured in small areas – preferably at night – by shutting off an area's supply line and only supplying the area with water via a connection from a fire hydrant outside the area to a fire hydrant inside the area.

To ensure that the valves shutting off the area are watertight, a "leak" test should be carried out

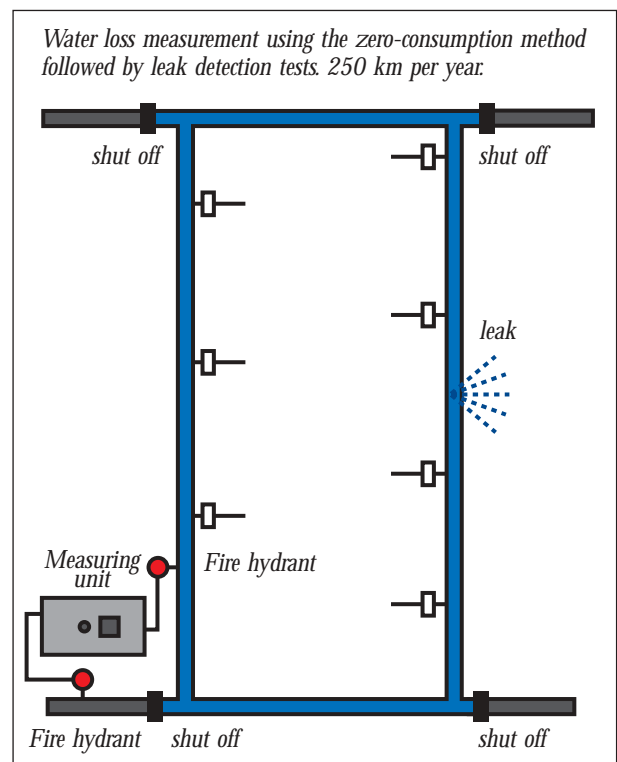

by closing the valves and opening a fire hydrant within the area (preferably a fire hydrant located on high ground). If the water pressure falls (the flow of water from the fire hydrant stops), the valves shutting off the area are watertight.

If the water consumption recorded for an area is higher than the permissible night-time consumption, the pipelines in that area should be examined in more detail.

Leak noise correlation and acoustic listening systems

Leaks can be traced using cross-correlation methods and electro-acoustic leak detection systems (humming sounds) – both of which are well-

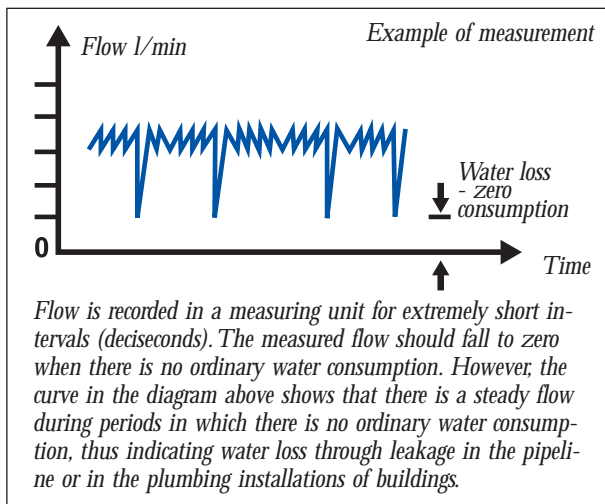

known techniques. However, to ensure rational and systematic leak detection these methods should be used to pinpoint leaks that have been indicated by one of the methods mentioned above.

Continuous monitoring

Continuous pipeline monitoring, in which consumption is observed around the clock via a control, regulation and monitoring system, is possible in simple pipeline systems. In more complex systems, measuring equipment can be installed in strategically positioned chambers along the pipeline and resulting data sent to a control, regulation

and monitoring system. Continuous data thus provides information on pipeline condition and whether there are problems in relation to predetermined values for normal night-time consumption and pressure.

Re-checking

After detected leaks have been repaired, elevated-tank and area measurements should be repeated for control purposes. After assessment, the new results can be used as reference values for future measurements.

Control measurements should also be made on the repaired pipeline section using leak noise correlation and acoustic equipment as the previous leak may have drowned out the sound of smaller leaks.

Acceptable water loss

The concept of "normal hourly night-time consumption" has been mentioned previously. Dutch investigations (see references) estimate this to be 0.5-1.5 litre/person/hour.

Other estimates (see references) of this acceptable water loss – the magnitude of which can be used to assess pipeline condition – are shown in the following table.

In addition, the Stuttgart water company has investigated water loss from new pipelines in several areas with 35-50 service lines per km supply lines. The investigation showed an acceptable total water loss of 3 litre/km/minute, corresponding to about 4.3 m³/km/day. The results from Stuttgart are thus in close agreement with those shown in the table.

The Stuttgart investigation also showed that the 3 litre/km supply line/minute loss could be divided into:

- 2 litre/km supply line/minute lost in plumbing fixtures in buildings (false water loss as a result of water loss, unmetered or incorrectly metered consumption), and
- 1 litre/km supply line/minute lost as genuine water loss.

Country	Pipeline age	Acceptable water loss m ³ /km/day	Comments
France	New	3	Less than 20 years old More than 20 years old
	Old	5 – 7	
USA	New	3.5 – 6	
	Old	5 – 7	

When should a leak be repaired?

As a general rule, if a leak can be recorded using electro-acoustic methods (humming sounds) then it is worthwhile repairing.

Results of a systematic leak detection survey

In 1989, the municipal utilities company supplying the city of Århus (Århus Kommunale Værker) in Denmark began planning a systematic leak detection survey in which the entire network was to be inspected within a 4-5 year period. In 1989, the total length of the pipeline system was approx. 1,220 km, and in 2000, the total length was approx. 1,440 km.

In addition to mapping the geographical location of leaks, an objective of the survey was to assess the quantity of water lost from individual leaks.

Systematic leak detection.



In the survey, the pipeline system was systematically divided into sections. Flow measurements were performed at night in individual sections in order to roughly determine the location of leaks and their size. Leaks were then pinpointed using leak noise correlation and electro-acoustic equipment (humming sounds).

Total water loss in 1989 was 12.7% (6.77 m³/km/day). In 2000, total water loss had been reduced to 5.7% (1.92 m³/km/day).

The extent of the survey is outlined in the following table.

Conclusion

Systematic leak detection on water pipelines can be a laborious and expensive process. Whether it is worth-while or not is a question of the costs of the work in relation to the savings achieved by reducing water loss. Using and developing rational techniques for leak detection will make the work easier and reduce its costs.

Factors other than cost-effectiveness may also affect the planning of systematic leak detection on water pipelines. These include the following:

- Less water must be treated at wastewater purification plants!
- Improved water quality (no infiltration)
- Improved customer relations (water companies must also be seen to be water savers)

Year	Length of pipeline investigated km	Number of leaks found	Total water loss from leaks found Litre/minute	Comments
1989	313	23	1180	1st inspection
1990	320	12	609	
1991	267	28	1090	
1992	169	11	2150	
1993	330	6	410	2nd inspection
1994	260	7	615	
1995	250	5	210	
1996	286	38	1830	
1997	223	12	880	
1998	328	8	455	3rd inspection
1999	183	3	280	

Example of letter with offer to property owners**(Property address)****Dear Mr/Mrs/Ms(property owner's name)****Re.: Replacement of your water service line**

As part of our ongoing programme of replacing old, worn out water pipelines, we will soon be laying new pipes in (road name). The work is due to start on around **4 February 2002** and is expected to be finished by **1 March 2002**.

In our experience, private service lines, i.e. those running between property boundaries and buildings, are usually in the same state of disrepair as pipelines owned by the water company. If water users on your property are to receive the full benefit of our pipeline replacement, it may therefore be necessary to replace the private section of the service line as well.

Service line replacement will ensure a more stable water quantity and improve water pressure. In addition, the risk of burst pipes will be reduced, and possible expenses relating to pipe repair, the repair of consequential damage and lost water can thus be avoided.

The water company would like to stress the importance of this replacement work, for in order to save water the pipeline system must be made as watertight as possible.

The water company can therefore offer to:

- supply new piping for the service line, up to 63 mm in diameter and 25 m in length, free of charge (extra costs for larger diameter piping or greater lengths must be covered by the property owner);
- weld service lines at the property boundary free of charge;
- contribute DKK ?? incl. VAT towards the cost of necessary plumbing work on the property (the contribution will be deducted from the bill from your plumbing contractor).

Replacing the private service line while the water company is working in your street will provide both economic and practical benefits. If you want to take advantage of this opportunity, please let us know which plumbing contractor you wish to use, and we will then co-ordinate the work.

For further information, please contact XX XXX on tel. XXXX XXXX as soon as possible. Office hours: Monday to Thursday 7 am to 3 pm, Friday 7 am to 12 noon.

Water company replacement of water pipes in public areas (i.e. beneath roads, streets and pavements) does not involve additional costs for consumers; replacement costs are included in the price of water.

Yours sincerely

4.1 Planning sewer rehabilitation

Several factors should be taken into account when planning sewer rehabilitation.

These include:

- Basic data
- Sewer physical condition
- Sewer importance for the functioning of the entire sewer system
- Sewer accessibility
- Sewer operational condition
- Sewer hydraulic condition
- Environmental aspects
- Co-ordination with other pipeline owners and authorities

Basic data

Competent planning should be based on sound data, and the more complex the system, the greater is the need for data.

The planning of sewer rehabilitation is greatly assisted by various sewer registration programs, which consist of a database component and a computer aided design (CAD) component. The database contains structured information on all aspects of sewer geography and physical properties, while the CAD component allows the information contained in the database to be presented together with other forms of relevant information.

Arbitrary data subsets can thus be presented in the context and setting that is most appropriate to the planning task in question. It is thus possible to obtain an overview of the sewer system and its condition; something that would, particularly in complex systems, otherwise be difficult to achieve.

Sewer physical condition

The physical condition of the sewer is an obvious and very important parameter for planning its rehabilitation.

The physical condition of sewers is surveyed using closed circuit television (CCTV) inspection, which in Denmark is performed in accordance with the Danish Control Scheme for CCTV Inspection Companies (Dansk TV-inspektionfirmaers Kontrolordning, DTVK) – see section 4.6. All data from CCTV inspections are imported into the database, after which they can be viewed using sewer registration programs. Following CCTV inspection, individual sewer lines are provided with a physical condition index (fysik indeks, FI), based on observed pipeline faults. The index, which varies from 0 (fault-free line) to 10

(defective line), provides a useful overview that can be used in planning to determine which sewers are in most need of rehabilitation. The physical condition index should, however, not be the only determining parameter in rehabilitation planning, but can provide a helpful initial ranking of sewer lines that require rehabilitating.

Sewer importance for the functioning of the entire sewer system

Ranking individual sewers for rehabilitation should take account of the fact that not all sewers have the same importance in relation to how the entire sewer system functions as a whole. The consequences of, for example, a main breaking down are much more severe than the consequences of a minor sewer failing in the upstream end of the system, because:

- Many more "consumers" are affected, and more basements are flooded
- Storm sewers come into use and untreated wastewater is discharged to recipients
- Substantial consequential damage can occur, e.g. erosion of the soil surrounding the pipeline with subsequent undermining and subsidence
- The cost of repairing consequential damage and of providing temporary arrangements (e.g. over-pumping) can be considerable

Sewer accessibility

Sewers in inaccessible locations, or in locations where access is difficult, should be given higher priority than easily accessed sewers. Inaccessible sewers include those that are located under roads with heavy traffic, streets with shops, railway tracks, watercourses and buildings, as well as those in water-bearing layers and those deeply buried.

The cost of repairing such sewers if they fail is naturally very high and failure often has far-reaching consequences.

Sewer operational condition

The daily operation of sewers provides much information that can be useful when planning their rehabilitation.

Sewer operators have the closest day-to-day contact with the sewer system and thus accumulate a wealth of knowledge on how the system is operating and where its weaknesses lie. Planners should utilise this knowledge wherever possible. It can, however, be difficult to obtain an overview of such information. Various types of computer



Operators carrying out inspection.

software capable of structuring and presenting information on pipeline operation have therefore been developed. Such programs are integrated with pipeline registration software.

Water jetting can also provide information on problem areas. The need for repeated flushing to keep certain sewer runs in operation, or the registration of large quantities of sludge during flushing can indicate that rehabilitation is needed.

A plague of rats often indicates that the sewer system is in poor repair and should therefore form part of the overall picture.

Finally, reports and enquiries from citizens and sewer users should be systematically registered. A survey of these can also provide valuable information that can be used in planning to pinpoint problem areas.

Sewer hydraulic condition

Insufficient capacity in part of the sewer system can be the primary reason for initiating a rehabilitation project. The capacity of combined sewer systems especially can become insufficient as the catchment area is gradually expanded and developed. In such cases, sewer capacity may gradually fall short of the objectives set by the municipal authority.

The hydraulic weaknesses of the sewer system are usually known to a certain extent by the personnel responsible for its day-to-day operation and will also be reflected in the registered reports of flooded basements or landscape received from citizens and users.

However, in order to locate and characterise the problems precisely, it is necessary to carry out measurements and calculations, most often in a

computerised sewer model (e.g. MOUSE/SAM-BA). The sewer model is then used to calculate the hydraulic design of the pipeline and its accompanying basins and structures so that the sewer system as a whole can meet the stated requirements after its rehabilitation in the catchment area has been completed.

Environmental aspects

In recent years, attention has focused on the effect of storm-related discharge from the sewer system (i.e. overflow from spillways and basins during heavy rainfall) on the recipients. These factors should be discussed with the recipient authorities in connection with discharge authorisation negotiations.

If these discussions lead to demands that discharge levels be reduced, alterations of the sewer system will inevitably be required. The hydraulic characteristics of these alterations should be designed using a computerised sewer model. It may necessitate establishing basins, pumping stations, etc., but the rehabilitation of one or more pipelines may also be required. Such considerations can therefore play an important role in the planning of overall pipeline rehabilitation.

The water-tightness of sewers also plays an important role in environmental considerations. Sewers that leak pose a risk of groundwater infiltration or wastewater exfiltration. Groundwater infiltration unnecessarily increases the hydraulic load on the pipeline, the pumping costs and the load on water treatment plant. It also results in adverse conditions for wastewater treatment.

Wastewater exfiltration poses a risk of soil and groundwater pollution. Water infiltration can be surveyed by analysing patterns of pumping station operation, supplemented with inspection of the quantity of water transported in the sewer system at night (at which time water use is assumed to be very low) and possibly also with tracer tests. In tracer tests, a tracer is added to the wastewater in a known concentration in the upstream section of the sewer system. The quantity of infiltrating water in each section of the pipeline can then be estimated by measuring the concentration of the tracer as it flows through the system.

Wastewater exfiltration from sewers is a particular problem in areas where drinking water is pumped from wells. In such areas it may be necessary to rehabilitate sewers with the sole purpose of ensuring that no leakage occurs.

Co-ordination with other pipeline owners and authorities

Much work is done on the various pipeline and cable systems buried beneath roads. This work is planned and performed by several authorities and pipeline owners. Such work should be co-ordinated in order to avoid such things as:

- Repeated excavation of the same road surface
- Disrupting traffic more than necessary
- Inconveniencing residents and property owners more than necessary
- Inconveniencing businesses more than necessary

The extent of this co-ordination varies from place to place and depends on many factors. Various pipeline owners may need to perform acute repair work at short notice and therefore cannot wait for a co-ordinated effort. In addition, pipeline owners do not have similar budgets and rehabilitation schedules therefore differ. Finally, political aspects can make planning and co-ordination difficult.

For co-ordination to be successful, contact between the various authorities and companies should be made early in the planning phase. The pipeline owners' plans for rehabilitation, the road maintenance authorities' plans for resurfacing and the town planners' plans for construction projects should be integrated as far as possible.

4.2 Choice of method for sewer rehabilitation

Sewers can be rehabilitated either by replacing them using conventional open-cut techniques or by renovating them using one of the various renovation techniques available. Many factors influence this choice, and if renovation is chosen, there are many factors that influence the subsequent choice of method. In addition, it must be decided whether the entire pipeline is to be rehabilitated or whether localised repair would be preferable in the light of pipeline condition.

Several factors that should be considered are described in the following. The topics covered should not be seen as a complete list, but rather as examples that will, hopefully, inspire planners and help them make the best choice in the actual situation. The benefits and drawbacks of individual renovation methods are described in the following sections.



Discussion of conditions before deciding on renovation method.

Technical aspects

Soft foundations/subsidence

Soft foundations in the form of subsidence-prone layers beneath the pipeline will often favour the choice of conventional trenching to rehabilitate the pipeline if it is deemed necessary to remove the soft underlying layer to maintain pipeline function. Some trenchless renovation methods can, however, realign sunken pipe sections where subsidence is less severe.

Collapsed pipelines

A pipeline that has already collapsed can be rehabilitated using conventional trenching, but it can also be renovated using trenchless techniques, pipe bursting for example. However, a pulling cable has to be inserted through the pipeline. Other renovation techniques will usually require that the collapsed section be excavated.

System separation

Conventional excavation is usually the most suitable method when systems that are currently combined are to be separated. Renovation techniques should be considered when existing pipelines are to be re-used in the separated systems.

Localised repair

If only one or a few pipeline defects are to be repaired, it may be appropriate to choose localised repair instead of complete pipeline rehabilitation. Localised repair can be performed using open-cut or trenchless methods.

Capacity aspects

Up-sizing

Pipelines with insufficient hydraulic capacity can be up-sized using conventional trenching or some of the trenchless renovation methods, depending on the extent of the necessary capacity increase.

Economic and timing aspects

Other work in the same area

Other work in the same area may include road recambering, road resurfacing and the renewal of other service pipelines and cables. Conventional trenching is often chosen for co-ordinated projects involving several parties as re-establishment costs can be split. Beautifully resurfaced roads are therefore often the result of completed rehabilitation work. Conversely, there are examples of defective pipeline sections (often sewer lines, which are generally buried deepest) being renovated before the road is to be resurfaced or other pipelines renovated. This can be an attractive option if the work has to be completed quickly or if the foundations of surrounding buildings or other factors favour this solution.

Number of laterals, manholes and other structures

The number of lateral connections, manholes and other structures to be rehabilitated can influence the choice of method. When assessing the various methods, it is therefore important to consider the sewer system as an entity comprising pipelines, laterals, manholes and so on.

Service life

Pipeline service life is crucial for the size of annual pipeline maintenance costs. If, for example, the service life of a pipeline is 100 years rather than 50 years, maintenance costs for the entire system over its service life will be halved. There is currently no systematic documentation of the durability of pipe materials. Some investigations of existing products carried out after they have lain in the ground for a certain number of years have, however, suggested service lives of 100 years or more. This is true of pipe materials used in both conventional and trenchless techniques. Service life is, however, also greatly dependent on the way in which the work has been carried out. In this context, it is important to note that quality assurance of the work performed is an important part of the process through which functional pipelines with long service lives are created.

Pipeline accessibility

Pipeline accessibility is of considerable economic significance and is therefore an important consideration when assessing the choice between conventional and trenchless rehabilitation techniques. Pipeline accessibility includes the following factors:

- Ground conditions – difficult ground conditions such as silt, fine sand and post-glacial deposits (i.e. former seabed, lake or marsh), high groundwater table, and polluted soil often affect the choice of renovation method
- Depth – the depth at which pipelines are laid greatly affects rehabilitation costs, not least in the case of conventional trenching
- Other pipelines, etc. – excavation costs will be greatly influenced by the number of pipelines, etc. to be dug free
- Pipeline re-establishment – in built-up areas, the cost of re-establishment is often higher than the pipeline price
- Traffic conditions – it may be necessary to divert traffic, or measures taken to keep traffic flowing may incur costs (e.g. pit coverings, safety cordons, signposts and traffic light systems)

Duration of rehabilitation work

A certain part of the costs involved in construction work are determined by the time to implement the work. Generally, trenchless renovation methods require less time than conventional open-cut trenching. The economic benefits of the work being completed quickly include:

- Reduced over-pumping costs
- Reduced costs for traffic regulation
- Reduced or eliminated compensation for damage caused by backflow and flooding
- Reduced or eliminated loss of turnover for shops and businesses as a result of blocked streets and roads

Drawbacks for the surroundings

Drawbacks for the surroundings include factors which from a technical and strictly economic point of view are of no importance when it comes to choosing between replacement or renovation. Drawbacks for the surroundings are best described as the inconveniences experienced by society and its citizens, and which involve high costs from a socio-economic point of view.

Drawbacks for the surroundings include the following:

- Traffic diversions
- Excavated gardens
- Restricted access to dwellings (for ambulances, oil delivery vehicles, refuse collectors, postmen, fire engines, etc.)
- Damage that becomes evident at a later date (to roads, other pipelines/cables, buildings, etc.)

Drawbacks for the surroundings are generally greatest in built up areas. Renovation is often an attractive solution where there is significant inconvenience.

4.3 Legislation on laterals

Ownership - in Denmark

A sewer system consists of many parts (pipelines, inspection chambers, manholes, etc.). Each of these main categories can again be subdivided. There are, for example, many types of pipeline (mains, branch lines and laterals).

This sub-section describes the function of laterals in the sewer system as a whole.

Danish legislation

An efficient sewer system is a vital part of modern society; citizens must be protected from infection by water-borne diseases through contact with wastewater. There are therefore legal requirements to ensure the efficient handling and subsequent treatment of wastewater.

The public sewer system

Municipal authorities are responsible for the installation and operation of the public sewer system, including mains, overfalls and wastewater treatment plants.

Legal requirements stress the importance of municipal planning and system development. This is achieved by compelling municipal authorities to prepare a wastewater plan that has to be revised at suitable intervals. Wastewater plans must be approved by the environmental authorities (in most cases the county authorities). Wastewater plans contain details of total sewer system discharge to recipients, drainage facility requirements (separate or combined sewer systems) and general requirements in connection with sewer system planning.

Recipient protection is assured by the requirement that municipalities must apply to the environmental authorities for discharge authorisation.

Such authorisation is based on the ability of the recipient to transport and break down the quantities of matter discharged.

No legal requirements exist for the dimensions of public sewer pipelines, but work is currently underway on a CEN standard to ensure the uniform design of sewer systems in the EU.

The private sewer system

Legally, private sewer systems (drains and laterals) belong to the building they serve, and must therefore comply with requirements contained in the Danish Building Act. This Act stipulates that all sewer/drain installations must be installed in compliance with DS 432 Standard for Effluent Installations (Norm for afløbsinstallationer) which is thus given legal status.

DS 432 contains requirements for the design of sewer systems, the materials that may be used in drain systems, and the way in which the pipeline system must be formed.

When planning the construction of a building, a drain plan must be prepared and subsequently approved by the housing authorities. Housing authority approval must also be obtained if significant alterations are made to the building (e.g. conversion or extension work) or if the sewer system is altered.

Approval is not required for repair work. All work on sewer systems must be performed by licensed sewer contractors.

The municipal authority, as the responsible environmental authority, is obliged to ensure that the private sewer system always functions in an environmentally sound way so that the environment is not polluted.

The Danish Environmental Protection Act (Lov om miljøbeskyttelse) gives municipal authorities unlimited authority to carry out investigations on private property as long as such investigations are part of the authority's environmental inspection work. Property owners cannot deny the authority access to their property. Property owners can be ordered to carry out necessary investigations if there is tangible evidence that private sewers are not functioning in an environmentally sound fashion.

If a municipal authority discovers that a private sewer is not functioning in an environmentally sound fashion, the municipal authority is obliged to ensure that the sewer is brought into reasonable condition, if necessary by issuing an order to this effect.

Norwegian legislation

The VA network in Norway is divided between private and public ownership at the lateral connection point. In other words, the lateral (i.e. the pipeline system between the main sewer connection and the building it serves) is owned by the individual subscriber. Property owners therefore have full responsibility to ensure that the system functions correctly and are fully liable for any situations arising from faults, etc. in the privately owned system.

Work performed on the private network is regulated by:

- The Norwegian Pollution Act

According to sections 22(2) and 51(1) of the Pollution Act (concerning drains) and section 1(3) of the sanitary regulations section 1(3) (Oslo), property owners can be ordered to carry out repair work or renovation.

4.4 Planning the rehabilitation of laterals

Types of laterals

Many construction types are drained via laterals, including buildings, road manholes, district heating channels and tanks.

In combined systems, where wastewater and rainwater are led through the same lateral, there is usually only one lateral per building, while in separate systems there is a lateral for wastewater and a lateral for rainwater.

Ownership of laterals

Laterals are defined as pipelines that connect drain installations within buildings (water closets, wash-hand basins, etc.) with the main sewer which is often situated beneath the road. Property owners always own the drain installations and that part of the lateral located within the property boundary unless otherwise stated in a covenant or registered in the property deeds.

In Denmark, laterals to kerbside manholes are considered part of the "road construction" and are therefore owned by the road owner whether public or private (see drawing below).

Laterals to other constructions, e.g. district heating channels, are the property of the pipeline owner.

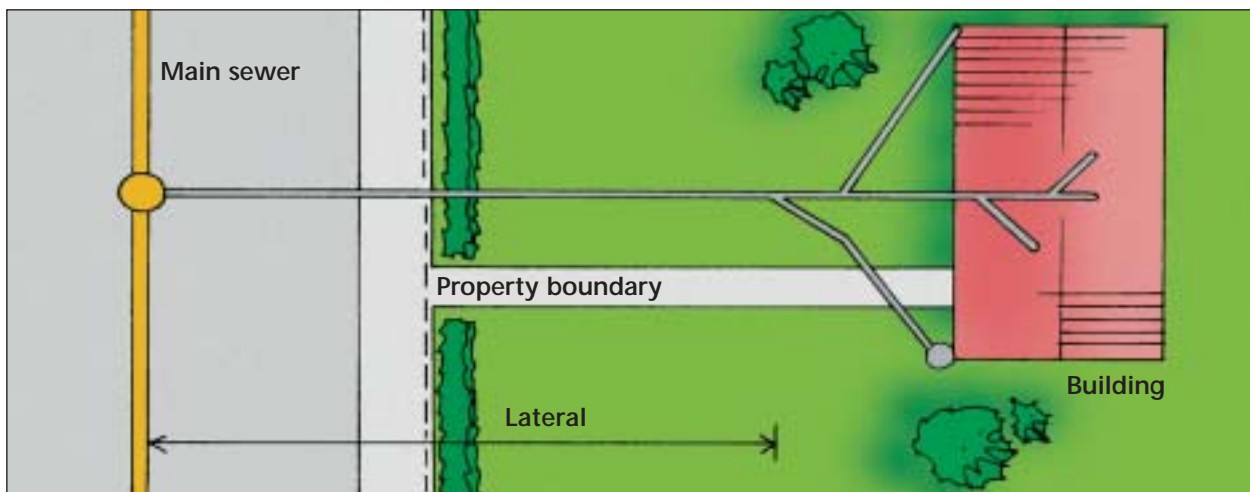

Design criteria

Just as drain installations are part of the building, so too are laterals, and the part within the property boundary must be designed in accordance with national standards and recommendations – in Denmark with DS 432.

Laterals must have sufficient capacity to carry wastewater and rainwater to the main sewer.

In areas with combined sewer systems, laterals must be designed to enable them to carry rainwater and wastewater simultaneously. In areas with separate systems, wastewater laterals and rainwater laterals must be designed individually in accordance with separate regulations.

In order to design a lateral in an area with combined sewers, it is necessary to establish the wastewater flow and the maximum rainwater flow.

Inspection methods

There are several methods for determining sewer condition. These are:

- Closed circuit television (CCTV) inspection
- Smoke testing
- Leak testing
- Tracer testing
- Gradient measurement
- Flushing

Closed circuit television (CCTV) inspection

The CCTV inspection of laterals is in many respects similar to the CCTV inspection of main sewers described elsewhere in this handbook. It is, however, possible to carry out CCTV inspection of laterals by inserting a camera into them from the main sewer. This allows the inspection of laterals that do not have a manhole or other means of access. Laterals ending in a water trap, e.g. in kerbside chambers, can be inspected right up to the water trap.

Camera equipment has gradually become so sophisticated that even small 100 mm diameter laterals can be inspected using CCTV. Equipment currently in use can also negotiate quite large obstacles, e.g. displaced joints and pipe fractures. It may be difficult to negotiate sharp bends, but it is expected that continued development will also solve this problem in the future.

Boundary manholes can, where they exist, allow access for CCTV inspection.

Drain installations must also be CCTV inspected. This can often be accomplished from a manhole as most drain installations have a collection manhole or boundary manhole. When inspecting



A CCTV operator inspects a lateral.

small laterals, it is possible to draw a cord through the pipeline which is then used to pull a miniature camera through the pipe. This method can be used to inspect pipes leading to roof drainage manholes, drains in floors, etc.

It is important that laterals be cleaned prior to inspection in order to achieve an optimum assessment of faults (e.g. displaced or open joints and pipe fractures). Special equipment has been developed to enable flushing from the main sewer.

Smoke testing

Smoke is used primarily to test whether sewer fractures and rat holes, road subsidence, etc. are connected. After igniting a smoke bomb in the sewer, smoke will diffuse through the sewer to the hole being investigated, if the two are connected.

Smoke can also be used to map connections in pipeline systems if there is doubt about which lines are connected.

Leak testing

Sewers are rarely tested for leaks, but leak testing can be used to check whether a pipeline is tight. This may be relevant for drains at chemical plants where stringent tightness requirements must be met.

Testing is carried out by plugging the lateral at the main sewer, blocking off all drains and pumping air into the system. The tightness of the pipeline system can then be assessed in relation to the pressure the system is able to maintain.

Tracer testing

Tracer tests, like leak testing, are seldom used because of the costs involved. It can, however, be advantageous to use tracers to locate leaks under basements or expensive surfaces.

Testing involves plugging the lateral at the main sewer and injecting water containing a radioactive tracer into all drains. The radioactive water is subsequently collected, and leaks can be located by measuring residual radioactivity.

Gradient measurement

Gradient measurement is used especially where there are problems with smells or frequent blockages caused by the lateral not being self-cleaning. Gradient measurement can be used to map pipeline gradient and locate sunken sections.

Gradient measurement is carried out by pulling a level-measuring device through the lateral.

Unfortunately, the measurements are subject to some uncertainty, but it is expected that more accurate equipment that can, for example, be used together with a CCTV camera will be developed.

Problems with laterals

Laterals are a vital part of an efficient sewer system, as they constitute approximately half of the entire system. Many of the problems that sewer authorities encounter in publicly owned main sewers may be caused by defective laterals.

The following problems can be directly attributed to laterals:

- Rats
- Overspill
- Infiltration
- Exfiltration
- Outdated installations



Rats find nesting places in unused and defective laterals.

Rats

Rats live in the sewer system where they find nesting places in unused and defective laterals and have access to sufficient food in the sewer.

The nuisance caused by rats has increased in recent years, thus indicating deterioration of the sewer system.

Rats pose a health risk and municipal authorities spend large sums of money on rat control in an attempt to limit their numbers.

Problems with rats are caused by faults and shortcomings in the sewer system, including:

- Pipe fractures
- Large, open, and displaced joints
- Unused laterals
- Inadequate plugging in connection with alterations

Overspill

In areas with separated sewer systems, a special problem is overspill from rainwater lines to wastewater lines. Overspill occurs on lateral sections where the two pipelines are close together – usually the section between the building and the first distribution manhole.

The consequences of overspill are that the separated system does not function as intended and that the small-bore sewer lines are overloaded.

In addition, wastewater is diluted resulting in more problematic and costly wastewater treatment.

Infiltration

Infiltration is a problem where sewer pipelines are buried below the water table and where groundwater can infiltrate the pipeline through leaky joints, lateral connections, etc.

Infiltration results in hydraulic overloading of pipelines and wastewater treatment plant, and consequent environmental impact.

In addition, surrounding material (e.g. sand and gravel) enters the pipeline and this is a seri-



Pumping station monitoring on the sewer network in connection with an infiltration survey.

ous problem for pipeline operation. It also results in increased wear and tear in the pipeline and mechanical components of the sewer system, including pumps, gratings, etc.

Another important problem is that such draining of pure groundwater disturbs the water balance and results in dried-out watercourses and reduced groundwater reserves.

Exfiltration

Seepage from sewers occurs in areas where pipelines are buried above the water table and where wastewater can leak from the sewer pipes.

Exfiltration burdens the environment, and there is a genuine risk that groundwater reserves will become polluted with chemicals from households and industry.

Outdated installations

It is still quite common to find outdated installations in the privately owned part of the sewer system, including interceptors, Imhoff tanks, cesspools and kitchen drainage manholes. These installations were legal when they were installed, but currently cause increased corrosion of sewer pipelines, accumulation of solid waste, and leaching to groundwater. In addition, they cause smell problems and provide breeding grounds for rats.

Survey of laterals

In 2000, the Danish Water and Waste Water Association (Dansk Vand- og Spildevandsforening (DANVA), formerly Dansk Afløbs- og Spildevandsforening (DANAS)) surveyed public and

private laterals. The survey was based on CCTV inspections of approximately 18.000 laterals distributed throughout Denmark.

The survey revealed that many laterals had faults and defects. More precisely, the survey showed that:

- 28% of laterals had faults and damage that needed repair
- 18% of laterals could not be CCTV inspected because of sharp bends, large blockages, etc.
- 11% of the connected laterals were not currently in use

Unused laterals

Laterals that are connected to the sewer system but are unused pose a particular problem because they can lead to:

- The undermining of roads
- Operational shutdown (collapsed laterals) with consequent lack of drainage
- Ideal conditions for rats with consequent undermining of roads, inconvenience for citizens, etc.

Unused laterals can result from:

- Buildings being demolished without the lateral being plugged
- Laterals being re-routed during building conversion
- Road manholes being decommissioned
- Old plugs rusting or rotting away
- Laterals being plugged at the property boundary (this is no longer permitted)

Distribution of unused laterals

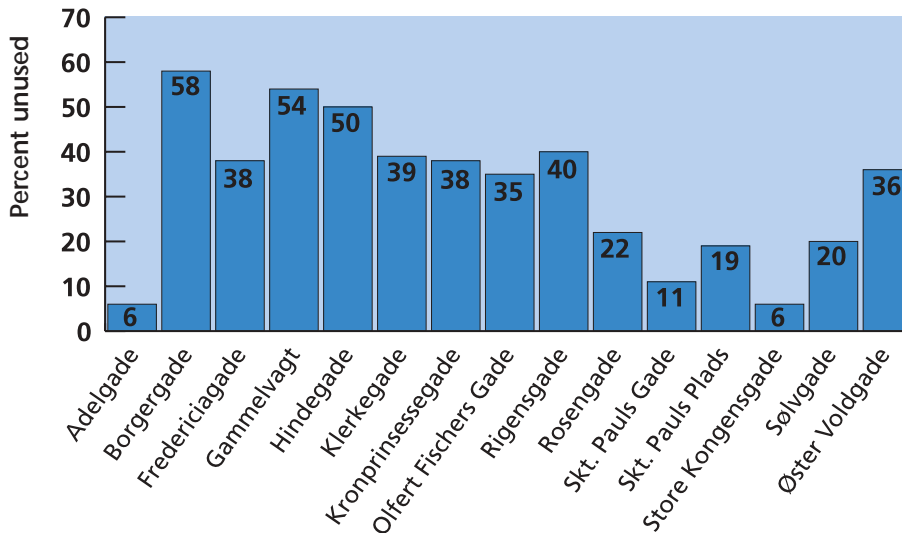

An example

A small survey carried out in the centre of Copenhagen shows the importance of including laterals in any investigation of sewer systems. All laterals in a small section of the sewer system were inspected using CCTV. As shown in the figure above, considerable variation in the number of unused laterals was found.

4.5 Choice of method for the rehabilitation of laterals

There are several NO-DIG or limited-dig methods for renovating laterals. These are:

- Cured-in-place lining
- Pipe bursting
- Close-fit lining

Cured-in-place lining

The technique of lining laterals with cured-in-place liners is almost the same as that used to line main pipelines (see chapter 8 – Cured-in-place lining).

The liner itself can be manufactured in many ways, but in principle it consists of a felt tube impregnated with thermal-cure or ambient-cure polyester or epoxy resin.

The liner can be installed from collection manholes, boundary manholes or the main sewer. The polyester or epoxy resin is cured by heating (either physically or chemically) or by ultra-violet light.

An important difference between installation from a collection or boundary manhole and installation from a main sewer is that it is only possible to form a watertight seal between the lateral and the main sewer in one operation if the liner is installed from the main sewer. This is achieved by fitting the liner with a transition piece profile that bonds to the main sewer. When installing liners from a collection or boundary manhole, the lateral connection can also be sealed by subsequently fitting a transition piece. Typically, the wall thickness of lateral liners is 4.5 mm.

Depending on the condition and design of the lateral, lining can either reduce or increase the hydraulic capacity of the lateral as this is determined by the cross-sectional diameter and the roughness of the renovated lateral.

Reducing the diameter of laterals usually reduces their capacity, but this is counterbalanced by the fact that liners are considerably less rough than unlined laterals and lining reduces hydraulic capacity loss in displaced joints, fractures, etc.

Cured-in-place lining can usually be used for renovating most laterals where there have been no problems relating to self-cleaning ability or insufficient capacity. However, the specific hydraulic characteristics of the lateral before and after renovation should always be assessed and compared with the characteristics of a newly established lateral.

In some situations, where a lateral has been established with insufficient gradient, but with the gradient available under the given circumstances, cured-in-place lining can improve the self-cleaning characteristics of the lateral.

Pipe bursting

The method is the same as that described for renovating main pipelines (see chapter 12 – Pipe bursting).

Pipe bursting is the only trenchless technique that can significantly increase the hydraulic capacity of laterals.

Pipe bursting is mainly used for laterals that have capacity or structural irregularities.

Close-fit lining

Many close-fit methods are available (see chapter 10 – Close-fit lining).

Close-fit lining reduces the cross-sectional diameter of the lateral in the same way as cured-in-place lining. The hydraulic characteristics and self-cleaning ability of the lateral should therefore be assessed before the method is used.

Close-fit liners, which are often easier to install than cured-in-place liners, are mainly used in laterals where considerable capacity reductions can be accepted.

4.6 CCTV inspection – the photo manual

At present, closed circuit television (CCTV) inspection is the tool most commonly used to improve our knowledge of the current condition of sewers. With this method, it is possible to monitor the internal condition of sewers by filming them with a small self-propelled camera. It is thus not necessary to excavate the sewer or physically damage it in any way.

CCTV inspection can provide sewer owners with information on the quality, capacity and operating condition of sewer lines. CCTV inspection can also provide information on the constituent parts of sewer systems (inspection chambers, manholes, and lateral connections). Such information may be unknown to the sewer owner, e.g. data on hidden inspection chambers and laterals established in Denmark by private owners prior to 1 January 1993, at which time ownership of laterals in public areas was changed in the payment terms.

From a quality point of view, CCTV inspection can reveal whether fractures, deformities, corrosion or other defects are serious enough to pose a risk of the sewer collapsing.

From a capacity point of view, CCTV inspection can provide general information on increased roughness which may prompt the sewer owner to adjust the parameters used for calculating hydraulic capacity, e.g. the Manning coefficient. CCTV inspection can also provide information on in-

truding laterals and displaced or open joints which all result in not unimportant efficiency losses in the sewer. Efficiency losses from such solitary obstructions and from friction can significantly affect the hydraulic capacity of the sewer line.

From an operational point of view, CCTV inspection can reveal locations where debris can accumulate, in sunken pipeline sections for example, and where there are specific obstructions with consequent risk of backflow and flooding of private basements.

As CCTV inspection is clearly a tool that has great importance for pipeline owners' knowledge of their sewers, and is basically the only available method of obtaining legally acceptable documentation of sewer condition, it is important that CCTV inspections be performed in a uniform manner and that the possibility of independent assurance of the quality of work performed be established.

These needs were also recognised by a group of forward-looking civil engineers almost 20 years ago when CCTV inspections were gaining ground in Denmark. As a consequence, the first Danish photo manual was introduced in June 1986. The photo manual was the result of collaboration between the four largest municipal authorities in Denmark, the Danish Technological Institute and Per Aarsleff A/S. The first photo manual came out in Sweden in 1989, and in Norway in 1994.

The current photo manual

Since they first appeared, the photo manuals have been revised several times in all the Nordic countries. Revisions have been primarily based on field experience with the manuals. The current Danish edition of the manual, whose official title is CCTV Inspection of Sewers, Standard Definitions and Photo Manual (TV-inspektion af afløbsledninger, standarddefinitioner og fotomanual), is the 4th edition from December 1997 (see references).

From the start, the photo manual was accepted by pipeline owners and contractors as a common "standard", and thanks to continued agreement, the photo manual has gradually achieved the status of current standard for the sector in all Nordic countries.

The photo manual has thus always been an integral part of the technical regulations in the Danish Control Scheme for CCTV Inspection Companies (Danske TV-inspektionsfirmaers kontrolordning (DTVK)). The purpose of this scheme

is to ensure high quality for all CCTV inspections carried out in accordance with DTVK regulations. The control scheme is described in more detail in chapter 19 of this handbook. In Sweden, Norway and Finland, the photo manual is used as a trade standard, but neither country has a special control scheme covering the area.

The latest revision of the Danish photo manual in 1997 was the most extensive in the history of the manual. Sections on definitions and reporting systems were extended so that CCTV inspection of renovated pipelines and laterals could be performed in accordance with the guidelines in the manual.

The photo manual currently consists of four separate sections dealing with:

- Main sewer lines
- Manhole inspection
- Laterals and drain installations
- Renovated pipelines (cured-in-place lining, close-fit lining and pipe bursting)

The current manual thus allows a more detailed description of all possible observations in a modern sewer system.

The Danish photo manual is prepared by pipeline owners, consultants and contractors. During each revision, draft copies are circulated for comments to selected municipal authorities, selected consulting engineers and the CCTV and NO-DIG working groups under the Danish Contractors' Association.

The purpose of the photo manual

The purpose of the photo manual is to ensure a uniform assessment of observations registered during CCTV inspection.

The manual therefore contains standard definitions that describe individual observations, and photographs that illustrate how the various observations may appear in the CCTV inspection.

Each observation is designated by a two-letter code (observation type) and a number (observation class).

All observations – apart from water in the sewer (VA) – are classified on a scale from 0 to 4, where 4 signifies conditions that are most negative for normal sewer operation.

In the photo manual, 18 observation types used in main sewers and laterals are described. In Denmark, 15 observation types that are deemed important for the assessment of pipeline condition are available to describe renovated pipelines. The observations contained in the photo manual are listed below. The column of numbers to the right signifies the number of classes the observation type may be split into.

In Denmark there is also an additional observation type for laterals that covers special constructions (KT). This category can, for example, be used to register where the CCTV inspection was terminated (water trap, blanking plug, duckfoot bend, etc.).

As it may be difficult to determine in which class an observation should be placed, the manual contains photographs of typical observations in the various classes.

To make the manual more user-friendly, it also contains a series of comments on individual observation types. These are basic functional descriptions which should always be used in CCTV inspections.

The photo manual contains detailed instructions on completing report forms. The codes used for computerised reporting comply with individual countries' accepted standards and exchange formats for the distribution of digital data from CCTV inspections.

			Observation- types
Main sewers and laterals:			
Physical condition:	Cracks/fractures	RB	1-4
	Corrosion/erosion	KO	1-4
	Casting flaws/honeycombing	ST	1-3
	Deformation	DE	1-3
	Displaced joint	FS	1-4
	Open joint	ÅS	1-4
	Loose joint material	IS	1-3
	Localised repair	PR	0-3
Operational condition:	Roots	RØ	1-3
	Infiltration	IN	1-3
	Encrustation	AF	1-3
	Deposits	UF	1-3
	Water	VA	%
	Blockage	FO	0-3
Special constructions:	Branch lines	GR	0-3
	Cut-in connection	PH	0-4
	Bored-in connection	PB	0-4
	Bend	RE	0-3
Renovated pipelines (only in Denmark)			
Operational condition:	Water	VA	%
	Infiltration	IN	1-3
	Encrustation	AF	1-3
	Blockage	FO	0-3
Cured-in-place lining:	Cracks/fractures	RB	A-F
	Deformation	DE	1-3
	Deformation	FL	1-3
	Loose inner foil	LI	1-3
	Discoloration	MI	1-3
	Cutting of lateral connection	OS	0-3
	Connection with transition profile	OP	0-3
	Lateral connection	TS	0-3
	Debris from work performed	RU	0-3
	Quality of work performed at start/completion	SS	0-3
Close-fit lining:	Cracks/fractures	RB	A-F
	Deformation	DE	1-3
	Cutting of lateral connection	OS	0-3
	Lateral connection	TS	0-3
	Debris from work performed	RU	0-3
	Quality of work performed at start/completion	SS	0-3
Pipe bursting:	Cracks/fractures	RB	A-E
	Deformation	DE	1-3
	Loose welding bead	LS	1-3
	Lateral connection	TS	0-3
	Quality of work performed at start/completion	SS	0-3

The use of observation type as acceptance criteria

The photo manual only contains a description of how an objective registration of the observations made in the sewer system should be performed and how they are to be reported.

If the CCTV inspection report is subsequently used to assess the sewer system (e.g. acceptance/rejection of new installations), the assessment must be performed in accordance with prescribed norms and standards for the construction work involved and with requirements stipulated in the tender documents.

The observation type Deformation (DE) can be used as a Danish example of why the CCTV inspection report cannot be used directly as acceptance criteria. The DS 430 Standard for Laying Flexible Plastic Pipes in Soil (Norm for lægning af fleksible ledninger af plast i jord) stipulates limits for maximum permissible deformation of 8% in PVC and 9% in PEH. It is, however, not possible to make such precise measurements of deformation using ordinary CCTV inspection procedures.

The classification is such that DE 1 is an acceptable degree of deformation while DE 2 requires further measurement, e.g. by pulling a solid mole through the pipeline to determine whether the deformation is acceptable in relation to the acceptance criteria.

A Danish example of a proposal for acceptance criteria for newly installed pipelines is given in the report Guidelines for Assessing Newly Installed and Renovated Pipelines Using CCTV Inspection (Retningslinier for vurdering af nyanlagte og renoverede ledninger ved hjælp af TV-inspektion) published by the Danish Technological Institute in 1997 (see references).

Reporting manhole condition

Manhole condition is not usually assessed using CCTV inspection, but rather by visual inspection, sometimes supplemented by photographs.

The Danish photo manual therefore contains a special section on the reporting of manhole condition in order to ensure uniform assessment of the observations made in connection with manhole inspection.

In principle, the way in which the design and condition of a manhole are registered is the same as for pipelines; the same descriptions, definitions, observation types and observation classes are used as far as possible.

However, the form for reporting manhole condition is designed so that it can also be completed in writing, although it is currently more usual that information and observations are registered electronically.

What does the future have in store?

The photo manual is a dynamic tool. Experience gained from its use and outside influences (e.g. work on CEN standards) will therefore lead to the revision of current standard definitions and report forms.

In recognition of this process, several national and Nordic projects are currently underway. These ongoing projects are expected to result in the publication of revised editions and supplements to the Nordic photo manuals in coming years.

Ongoing Danish projects will be described briefly in the following.

Cured-in-place pipelines

The section on CCTV inspection of cured-in-place pipelines in the photo manual from 1997 has not been sufficiently precise to meet the requirements of pipeline owners and contractors. This is partly because more experience has been gained in the installation of cured-in-place liners, and partly because contractors have gained more experience, and now have improved tools at their disposal for reinstating laterals. As a result, the current classification and description of observation types for cured-in-place pipelines is not up to date.

The Danish photo manual working group has therefore prepared a second edition of the photo manual for cured-in-place pipelines for publication in the spring of 2002 (see references).

Prior to publication, the working group amassed the experience gained by several municipal authorities in the use of CCTV inspection reports for cured-in-place pipelines. Subsequently, the group discussed suggestions for new observation classes. In particular, descriptions of the observation type "cutting of lateral connection" were fully revised.

In addition, extremely detailed photographic material has been collected to document the new observation classes. Thus, each observation class is not merely illustrated by a single photo, but several photos are often used to illustrate the various causes of a class. Similarly, several photos of, for example folds, are used to illustrate when an ob-



The new photo manual for cured-in-place pipelines, published in 2002.

ervation is sufficiently insignificant for it not to be registered.

As Danish CIPP contractors are subject to stringent quality requirements, via among other things their membership of the Danish Control Scheme for Pipeline Rehabilitation, it has proved extremely difficult to find examples of sewers with observations in more critical classes. The photo manual working group therefore set up a test pipeline in order to be able to provoke defects that could provide photographs illustrating relatively rare observations in the more critical classes.

The other Nordic countries have only limited experience in this field. The photo manual working group therefore hopes that the new manual for CCTV inspection of cured-in-place pipelines will in time form the basis of a common Nordic manual. In any event, use of the manual will be justified in Denmark for several years to come as the current suggestion for a CEN standard only treats cured-in-place liners superficially.

CCTV inspections of pipelines renovated with close-fit liners or pipe bursting techniques must still be registered in accordance with the 1997 edition of the photo manual.

Harmonisation of the reporting system

Extensive revision of the current Danish photo manual is planned for 2002. In this connection it would be natural to investigate the possibility of registering main pipelines, laterals and renovated lines in any one CCTV inspection in the same reporting system.

Such harmonisation could solve many problems for operators, i.e. they would not have to decide – as they do at present – which report form to use.

Take, for example, a short liner in a main sewer. The liner may have been inserted to

strengthen the pipeline beneath a road with heavy traffic. The operator begins the CCTV inspection using the report form for main sewers. On reaching the lined section, the operator must switch to the form for renovated pipelines, and then switch back again on reaching the end of the lined section. This procedure is not practical, especially when the operator must decide – on the basis of the length of the lined section – whether the lined section should be registered as a localised repair or as a renovated pipeline.

The operator as assessor

Another part of the forthcoming Danish revision will examine situations described in the photo manual where the operator must make an assessment, e.g. in the case of branch lines, localised repairs and bored-in connections where the operator must decide whether the observation in question is good, average or bad.

Operators are not trained to make such assessments. In connection with the photo manual revision, the working group has therefore set as an objective that operators must be able to report what they actually see. The photo manual will therefore include detailed descriptions of the conditions operators can expect to find in their daily work.

Redesigning the system so that it contains descriptions rather than assessments does not mean that the classification system, which is also currently used in the other Nordic countries, will become redundant. It simply means that (for each class) descriptions must be provided to pinpoint the actual observation which will lead to a given class selection.

This will mean that operators are relieved of the responsibility of making assessments that can be of great significance in choosing a particular renovation method.

CEN standard and associated Nordic annex

Work on a common CEN standard has naturally provided the opportunity of incorporating relevant sections of it in the Nordic photo manuals. In particular, it can be expected that needs will arise in connection with large EU tenders for CCTV inspection to convert data between the standard CEN format and the Nordic classification system. In Denmark, the photo manual working group will as far as possible attempt to incorporate the necessary additions for such conversion in the forthcoming revision of the manual.

In continuation of the work on the CEN standard, thoughts have been aired on preparing a common Nordic photo manual. These ideas have been fostered because the proposed CEN standard for sewer investigation opens the possibility of individual member states preparing a national annex to the common standard.

The productive co-operation between the Nordic countries during negotiations on the proposed CEN standard has shown that it is realistic to believe that a common basis for CCTV inspection in the Nordic countries could be found. Revisions to the current photo manual must, of course, take into account the adaptations resulting from this co-operation.

Registering manhole condition

In particular, the current description for registering manhole condition is inadequate.

Here, too, it will be possible to draw on the work being carried out on a common European CEN standard, which contains a very detailed description of the reporting of manhole condition.

The Danish photo manual working group will endeavour to incorporate this revision in the forthcoming edition of the photo manual.

5.1 Tendering in Denmark

For many years, NO-DIG projects have been tendered with greatly varying conditions, mainly because of a lack of knowledge of the renovation methods applied. This has often led to difficulties and dissatisfaction on behalf of both pipeline owners and tendering contractors.

As a result, several local authorities and the NO-DIG group under the Danish Contractors' Association have prepared a paradigm for tendering NO-DIG projects: Renovation of Sewer Lines. Paradigm for Inviting Tenders, Description, and Guidelines (Renovering af afløbsledninger. Paradigma for udbud og beskrivelse inkl. vejledning, 1. udgave, 1999). Copies of the tendering paradigm can be obtained from the Pipe Centre, Danish Technological Institute.

The tendering paradigm ensures that all renovation projects are tendered on a common basis by taking into account current experience with known renovation methods, by incorporating present knowledge on future European standards, and through the work done under the Danish Control Scheme for Pipe Rehabilitation.

However, the tendering paradigm covers only cured-in-place lining, close-fit lining, long-pipe lining and pipe bursting, and can only be used for gravity sewers. Localised repair, directional drilling, impact moling and conventional open-cut methods are thus not included in the model.

The tendering paradigm contains proposals for invitations to tender and conditions for tenders and payment. These sections are constructed so as to take account of varying conditions in individual contracts. In addition, the tendering paradigm contains proposals for TAB (Annex to AB 92), SB (Special Conditions) and AB (Work Description). These three sections are general descriptions that in time will hopefully become known in the industry as a "permanent" part of any tender for sewer renovation. The idea with the tendering paradigm is that changes need only be made in invitations to tender and the conditions for tenders and payment, while TAB, SB and AB remain unchanged from one invitation to tender to another.

The tendering documents also contain instructions, suggestions, reminders and references to help the party inviting tenders to remember all important information and thus ensure that tendering is performed in a uniform and competent manner.

Inviting tenders for renovation projects

A new Danish act on competitive tendering took effect as of 1 September 2001. All NO-DIG work offered for tender by public authorities is covered by the new act. There are changes in relation to the old act, but in the case of NO-DIG projects, these changes are not great.

The act stipulates that the contract is to be awarded to the contractor who either has the "lowest tender" or the "the economically most favourable tender". The "lowest tender" is more or less the criterion that was used prior to 1 September 2001.

The concept of "the economically most favourable tender" is well-known from the various tendering directives that have been in use for several years. The tender documents must state which of the two criteria will be used to assess submitted tenders. If "the economically most favourable tender" criteria is used, the award conditions and associating weighting must be given.

Public tendering

Calls for public tenders must be advertised in newspapers. The advertisement must describe the extent of the project. Calls for tenders for NO-DIG projects should be advertised in national newspapers, possibly also in the Danish publication *Licitationen*. The advertisement should describe deadlines and the award conditions used. The advertisement must provide sufficient information for the contractor to be able to judge whether the project can be completed with the equipment that the company has at its disposal.

Contractors who wish to submit a tender should request that tendering documents be sent to them against payment of a deposit.

There are no set deadlines for receipt of tenders in the act. In the "old act", the deadline was approximately three weeks. The deadline must give contractors enough time to prepare a tender. As it is in the interests of the sewer owner that contractors thoroughly investigate the actual conditions, it is recommended that the time given reflects the extent of the project in question. Contractors should be given a minimum of give working days for small contracts. For large contracts, where quotations from sub-contractors may be required, contractors should be given 15 working days to prepare tenders.

In public tendering, contractors who have offered tenders have the right to be present when

the tenders are opened, and to be informed of prices and provisos.

Public tendering ensures broad competition in which contractors who are capable of accomplishing the project can submit a tender.

Public tendering entails a risk that an unsuitable contractor will submit the lowest tender. It is, however, possible to reject a tender if the sewer owner deems it likely that the contractor will not be able to complete the work in a satisfactory quality within given deadlines. Upon request, the sewer owner must forward reasons for rejecting a tender.

Tenders submitted by contractors are binding for 40 days.

Limited tendering

Limited tendering corresponds to what was known as invited tendering in the "old act". In limited tendering, only a select group of contractors is invited to submit tenders.

Limited tendering is common practice for NO-DIG projects because there are only a few contractors capable of offering tenders of this type in Denmark.

With limited tendering, there is no need to advertise. Instead, a letter is sent to relevant companies describing the project and enquiring whether the company wishes to tender.

If a company wishes to tender, it must apply for the tendering documents in writing.

The tendering documents must describe the award conditions to be used in the assessment ("lowest tender" or "economically most favourable tender").

The same conditions also apply to limited tendering.

In limited tendering, only contractors whom the owner deems capable of accomplishing the project are invited to submit tenders.

There have been cases where limited tendering has resulted in contractors "getting together" and offering identical high-price tenders. This is known in the trade as "tender fixing". The sewer owner always has the possibility of cancelling a call for tenders and issuing a new one – either in a different form or by inviting the same or a new group of contractors to submit tenders.



Tenders for NO-DIG projects can be invited by public tendering, limited tendering or informal tendering.

Informal tendering

Informal tendering is also covered by the new act, but those calling for tenders are no longer limited to inviting two contractors to offer tenders. Informal tendering is to be regulated by an executive order, but this has yet to be issued (September 2001). The same is true for framework agreements.

6.1 Social costs

Pipeline work can have considerable negative effects on the surrounding environment, especially pipeline work in existing buildings.

In particular, effects take the form of disruption of traffic and transport, burdens on the environment and pipeline operators' work environment, and inconvenience for commerce, industry and local residents. Factors that usually form the basis of social cost evaluations will be discussed in the following.

Social costs in this context refer predominantly to the disruption of traffic, transport, the environment, the work environment of pipeline operators, commerce, industry and residents in the vicinity of pipeline work.

Not all these "costs" can reasonably be expressed in terms of pounds and pence. For further details see appendix A (Methods of evaluating social costs).

If a municipal authority wants to work actively with these aspects, it is a very good idea for them to prepare and adopt a policy which includes the objectives and requirements that local councils have decided upon.

Social costs also include the costs that are neither direct nor indirect costs of the engineering project.

Direct costs usually include costs relating to:

- Planning, design and inspection
- Materials and construction work
- Reestablishment of roads, parks, etc.

Indirect costs usually include costs relating to:

- Damages paid to the owners of affected properties
- Damages paid to third parties
- Additional maintenance of roads and pavements during construction work (but seldom after construction work)

However, negative effects can be minimised by appropriate planning, choice of construction method and timing of construction work.

To assist in this work, several tools and methods have been – or rather are being – developed. The most promising and relevant of these are discussed in appendix A.

Inconvenience/disruption for the surroundings

For traffic and transport, the following are usually important:

- Delays – e.g. for buses, cars, ambulances, fire engines and refuse collection vehicles
- Increased vehicle running costs
- Impaired access to shops, businesses, hospitals
- Impaired access to car parks
- More frequent accidents
- Additional hazards for pedestrians and cyclists ("soft" traffic)

For the environment and surroundings the following are usually important:

- More noise, smells and dust
- More air pollution
- Vibration
- Disruption of street life (how to find your way around the work site)
- Increased pollution because of sewer overflow during rainfall

These factors are generally covered by the environmental impacts that affect health and the environment at large – see appendix A.

For commerce and industry the following are usually important:

- Reduced turnover in local shops
- Disrupted delivery of goods to shops
- Impaired access to shops

For local residents the following are usually important (see also the section on the environment and surroundings):

- Impaired access to dwellings
- Often no vehicle access
- Disruption of normal everyday life

These lists of inconveniences and disruptions are not exhaustive, but show the factors most commonly used in social cost calculations.

Objectives for acceptable disruption

Municipal authorities and pipeline owners should always base their assessment of which disruptions in connection with a construction project are acceptable in terms of the desired political objectives and requirements.

Objectives are set in order to provide tangible management tools. If the objectives are measurable, precise and realistic, individual construction methods can be assessed and compared in terms of the disruption they cause.

If when determining social costs, only objectives and requirements are used in the evaluation of tenders, the process should be performed on the basis of specific objective control – see appendix A.

Examples of various types of objectives and requirements:

- Excavation in connection with the renewal or planned maintenance of municipal technical installations must not occur in any road more than once every 25 years
- Excavation in connection with acute maintenance of municipal technical installations must not occur in the same road more than once every 5 years
- From 7 am to 9 am and from 3 pm to 6 pm only 25% of road width may be blocked
- All excavations must be completely covered between 3 pm and 7 am.
- Work sites used during construction must not be used for more than a week. Work sites in roads and pavements may only extend 100 m at a time
- If the stipulated work period is exceeded, liquidated damages of DKK XX per day shall be payable. If the work is completed before the stipulated date, the owner shall correspondingly pay DKK YY per day
- The work site area should be weighted in the assessment of the tender
- Only a 5-minute increase in the time taken to pass a work site will be accepted between 7 am and 9 am and between 3 pm and 6 pm.

Similar – more or less stringent – objectives and requirements may be set for all other areas of social costs.

Individual owners can thus determine what will be accepted and what will not be accepted. Requirements may be grouped as in section x.1.1 above with respect to:

- Traffic and transport
- The environment and surroundings
- Commerce and industry
- Local residents

For further details, see environmental impacts in A.

6.2 Product life cycle assessment and environmentally friendly design

In recent years, attention has increasingly focused on using as little as possible of the Earth's non-renewable resources, on recycling as many resources as possible after use, and on creating as few environmental impacts and environmental effects as possible when producing raw materials and products, when using the products and when operating, maintaining and disposing of the products.

If a municipal authority wishes to work actively with these aspects, it is a very good idea to draw up and adopt a policy which includes the objectives and requirements that local councils wish to achieve.

Life cycle or "cradle to grave" is used to describe products that normally have the following five phases in their life cycle:

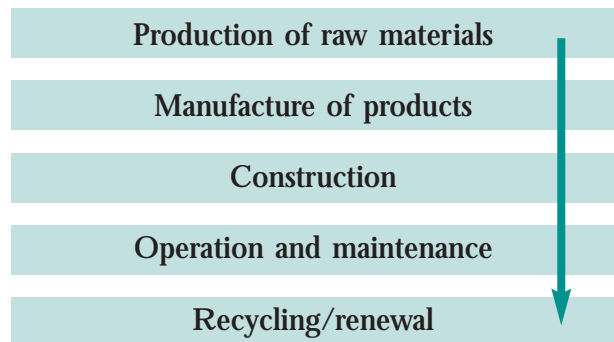

This is also true for construction work. In brief, the life cycle is as follows.

To manufacture a product, various raw materials are extracted and produced. Various building materials are then manufactured, and buildings and installations (e.g. pipelines) constructed.

Subsequently, these buildings and installations are operated and maintained. Finally, buildings/installations that cannot or shall not be used any longer are demolished and the materials and installations recycled or disposed of, while other buildings and their installations are renovated so that they can meet current standards and requirements.

This is also true for water supply systems, sewer systems, gas supply systems, telecommunication systems, etc. In other words, all the areas in which SSTT promotes NO-DIG techniques for installation and rehabilitation.

In this connection, several tools have been – or rather are being – developed, in particular life cycle assessments and environmentally friendly design. These tools are described in more detail in appendix A.

Users can, for example, utilise the results of these tools to document that they are complying with their company's environmental objectives. This will usually entail the identification of particularly significant environmental impacts in one or more phases of a product's life cycle (production, construction, operation, etc.).

In addition, the results can be used in connection with eco-labelling and environmental product specifications (the Nordic Swan, the EU Flower, etc.).

Suppliers can, for example, utilise the results to document the environmental impacts and effects of their products and processes. In the field of NO-DIG, this will usually consist of supplying detailed information and data on the company's NO-DIG methods and products.

A preliminary, outline life cycle assessment can often identify the most significant environmental impacts. This means that suppliers can benefit from using the results in their product development, license agreements, comparisons when purchasing materials for their production of liners, etc. and when purchasing machinery.

Several life cycle assessments of, for example, pipe materials from the beginning of the 1990s show that the severest environmental impacts (energy consumption and emission in particular) occur when using machinery during the installation phase, and that knowledge of environmental impacts in the long operational phase is very limited. In this respect, special reference is made to Environmental Assessment of Sewer Pipes Made of PVC, PE, PP, and Concrete (Miljøvurdering af afløbsrør i PVC, PE, PP og Beton) (see referen-

ces) published by Nordisk Plastrørsgruppe, and How to Interpret an LCA Report? (Hur tolkas en LCA-rapport?) (see references) published by VA-Forsk in 1998.

In the latter report, several experiences and pitfalls in the use of life cycle assessments and the resulting reports are described.

In conventional pipeline work, the installation phase is characterised by high energy consumption and emission in connection with transport, trenching and back-filling.

In 2002, Nordisk Plastrørsgruppe will publish a new investigation of environmental impacts and economic consequences of sewer system operation. The investigation focuses on blockages, infiltration, etc., and also deals with the use of vehicles for flushing as well as the operation of pumping stations and water treatment plants.

The methods themselves are discussed in appendix A.

Machines, for example, can be compared on the basis of their use of fuel, noise level and emission of CO₂, SO₂, see the list in the following section on environmental impacts.

A few definitions

At this point, it may be helpful to establish a few definitions. Many new terms appear in our "modern world" – and unfortunately different terms are often used for the same concept.

Life cycle assessments

"A life cycle assessment is a systematic collection, investigation and evaluation of environmental impacts and consequent environmental effects that a structure or building component give rise to throughout its entire life cycle."

A "structure" in this context can be a sewer pipeline, a pumping station, a water mains, etc.

Broadly speaking, a life cycle assessment can be defined as a techno-scientific tool for mapping and evaluating environmental impacts and the consequences of all the activities in the life cycle of a structure. It is techno-scientific because the evaluations broadly used at present require substantial technical knowledge of both the structure being assessed and the methods employed in life cycle assessment (see appendix A for further details).

Environmentally friendly design

Environmentally friendly design is a systematic design method which ensures that efforts to reduce the negative environmental effects of a structure throughout its life cycle are made during its design.

Life cycle assessments and environmentally friendly design are therefore two sides of the same coin – both aim to produce the fewest possible and least harmful environmental impacts, environmental effects, and consequences of a structure.

Environmental impacts and environmental effects are therefore two central and decisive factors. In the context of environmentally friendly design, environmental impacts and effects are defined as follows:

Environmental impacts

Environmental impacts are impacts caused by the structure during its construction and life cycle that result in effects on resources, human health and the environment at large.

Environmental effects

Environmental effects are any change in resources, human health and conditions in the environment at large.

Environmental impacts

On the basis of their definition, environmental impacts (and effects) are usually divided into three main groups:

- Impacts that result in effects on resources
- Impacts that result in effects on health and the environment at large
- Impacts that result in effects on health in the work environment

For each of these, the parameters and conditions usually taken into consideration at present, are listed in the following.

Where life cycle assessments and environmentally friendly design are concerned, it is these parameters and conditions that users and suppliers must take into account in all stages of the life cycle of a structure (see above).

Impacts that result in effects on resources

- Energy – the consumption of various energy sources
- Raw materials – the consumption of all materials used in the structure/product
- Water – especially the consumption of clean drinking water

Impacts that result in effects on health and the environment at large

- Emission to the atmosphere (that affects the global, regional and local environment – greenhouse effect, effects on the ozone layer)
- Discharge to water (wastewater that contains material foreign to the environment)
- Discharge to soil (chemical and biological substances that can cause long-term or permanent pollution)
- Energy production
- Material production
- Transport
- Waste treatment
- Waste disposal
- Noise and vibration (the noise level produced by machinery, etc.)
- Altered physical surroundings (alterations of structures and their surrounding)

Attention is usually focused on: NOx, CO, CO2, SO2, VOC, PAH, heavy metals, halogens, CFC gases, dust, cyanides and dioxins, but it is also important to consider other substances that may harm the environment.

Impacts that result in effects on health in the work environment

- Air quality (gases and particles/dust, allergy)
- Skin irritation (physical contact with dangerous substances, allergy)
- Thermal conditions (temperature)
- Light and radiation (weak and strong light, ionising radiation, radioactive radiation, cancer)
- Noise and vibration (noise levels and vibration from machinery, hearing damage)
- Ergonomics (physical exertion and occupational injuries)

Environmental objectives

Environmental assessments performed by municipal authorities or other pipeline owners should always be based on a set of politically desirable objectives and requirements.

Objectives are set in order to have specific management goals. If the objectives are measurable, precise and realistic, they can be used to weigh the environmental effects of various installation methods against one another.

Examples of overall objectives and requirements are:**Work environment**

Environmentally harmful substances must not be found at municipal workplaces or in municipal buildings and plant.

The condition of all manholes and structures must at least comply with the requirements of the Danish Working Environment Service and must be such that the work environment provides motivation for responsible and quality-conscious operation and maintenance.

Products

Products used in municipal buildings and plant must be manufactured, installed and operated throughout their service life consuming a minimum of energy.

Surroundings

The installation, operation and maintenance of municipal buildings and plant must inconvenience local citizens and visitors to the municipality as little as possible with regard to noise, dust and smell. The surroundings must also be inconvenienced as little as possible in connection with work sites, reduced traffic safety, damage to public parks, etc.

Such overall political objectives must usually be described in detail and made measurable as required. Corresponding and more or less stringent objectives and requirements can then be set for all other types of environmental effects.

In this way, limits are set for the extent of environmentally friendly design in the municipality and for the assessment of results: What is best for the environment in the municipality?

7.1 Cleaning sewer lines

It must be said at the outset that this section describes solely how the cleaning of sewer lines can be dealt with. The cleaning of, for example, water supply lines is not described here since this process is only undertaken to a very limited extent.

For as long as there have been sewers, it has been necessary to find methods of cleaning them out when they become blocked by sludge or other debris.

There are many ways of cleaning out drains and sewers, but since the 1960s the most used method is high-pressure flushing.

Despite the relatively long period during which high-pressure flushing has been used, and despite the fact that this method constitutes a certain health hazard for the personnel carrying out the operation, there are at present no general guidelines or instructions that manufacturers, operators, or administrative staff have to follow when sewer lines are to be cleaned.

When sewer authorities invite tenders for cleaning tasks, the only rules that apply are those laid down in Statutory Order on Sewers, no. 473, (“Bekendtgørelse om kloakarbejde m.v.”), issued by the Danish Working Environment Service. This service has also issued an Information Note (“at-meddelelse”) dealing with high-pressure flushing equipment (see references).

In addition to the above mentioned Statutory Order on Sewers there is also DS 432:2000 “Norm for afløbsinstallationer” (“Standard for effluent installations”) (see references), but this merely states that sewerage constructions shall be laid so that “all parts can be cleaned easily”. The standard does not apply to main sewers.

However, the issue of a Danish standard on the subject is expected soon. The technical committee of CEN therefore submitted CEN/TC 165 “Management and Control of Sewer Cleaning Operations in Drains and Sewers” (see references) for hearing in the spring of 2001. It is expected that after approval, it will become a Danish standard.

When a sewer is cleaned, the personnel involved will have gained their qualifications exclusively on the basis of experience exchange. This is of course a vital factor in ensuring expertise, but does not necessarily mean that personnel have been instructed in sewer construction, sewer function, types of material used, health and safety requirements, etc.

At the moment, work is proceeding on a Danish guideline dealing with requirement specifications for planning, personnel, equipment and methods of work for high-pressure flushing. In addition, efforts are being made to establish courses of training in this area. Among other things, these activities are aimed at achieving improved cleaning, preventing damage in pipes and, not least, preventing occupational injuries.

Norway and Sweden are among the countries which have established such forms of training. The training is not obligatory on companies who undertake such work in the countries concerned.

As can be seen from the above, cleaning pipelines is not a task that has been thoroughly investigated, described and documented. It demands much of the companies undertaking the task; they must use the correct material, and the work must be performed in accordance with current legislation. It is these conditions that are particularly emphasised in the following.

7.2 Planning the cleaning assignment

It is the municipalities in Denmark that are responsible for the operation and maintenance of public sewerage systems. It therefore goes without saying that within the authority departments concerned, the focus should be on maintaining sewerage systems and thus minimising to the greatest extent possible the number of emergency call-outs or other operational disturbances.

The following deals mainly with large planned cleaning assignments, not forgetting that even minor tasks also involve many of the points mentioned.

The basic preconditions for the successful completion of a cleaning assignment include:

- Thorough planning
- Well-qualified personnel
- Correct and well-maintained equipment
- Knowledge of the sewerage system

In general, where pipeline cleaning is concerned, the first step is to determine the strategy to be used.

Among the alternatives are:

- Periodic cleaning (at fixed or variable intervals of time)
- Cleaning based on inspection
- “Fire fighting”, i.e. dealing with serious problems after they occur

Probably the most used strategy is periodic cleaning at more or less fixed intervals. The procedure is fairly simple to administer and is based, typically, on reports from the personnel who perform such work. An example here would be an existing line not designed to be self-cleaning and which therefore needs periodic cleaning in order to avoid capacity or smell problems.

Preventive cleaning should be adopted to ensure the following:

- The continued maintenance of the necessary hydraulic capacity in the sewerage system
- The avoidance of blockage problems
- Minimum pollution from overfalls
- Minimum smell nuisance
- The possibility of TV inspection facilities
- The preparation of renovation work

To be able to deal with preventive cleaning correctly, it is important that information sent in by personnel in the field be utilised. In addition, to ensure that the reports sent in do contain the information required, the forms or tables used must be designed accordingly. If this is not done correctly, personnel will regard such documentation as a waste of time and reporting will never be as expected.

Briefly, the documentation for further planning must be exactly right, neither too much nor too little. What is more, the sewer maps used in planning must be a true representation of real conditions.

Choosing the cleaning method

The method of cleaning must thus be determined and the reason why cleaning is necessary must be established. For example, if the condition of the system is very poor, thorough flushing or light high-pressure flushing might be enough to restore capacity. In other cases, there is the question of whether or not high-pressure flushing of any sort might dislodge the packing yarn used to seal joints – with the result that the pipes fall apart. Further questions revolve around possible intrusions from service lines and whether root cutting might damage a service line, etc. Older cast iron pipes should not be high-pressure flushed unless they can be subsequently renovated using, for example, a NO-DIG method. Renovation enters the picture here because of the high risk of leakage presented by graphite grey iron pipes.

The following factors should be considered/investigated when choosing the method of cleaning:

- Reason for cleaning
- Material, size and sealing materials in lines
- System condition
- Rate of flow in system
- Manhole positions, distance between them, traffic conditions
- Amount of information to be given to residents and authorities

A decision then has to be taken as to the form of cleaning to be adopted in each particular case. There are many different methods, but the most widely used in Denmark are:

- Manual drain cleaners
- Cleaning rods
- Sewer cleaning machines
- Cleaning balls
- Digging and scraping implements
- High-pressure flushing
- Root cutting
- Cleaning pig

Alternative preventive cleaning methods used in Germany, Denmark and other countries include vacuum systems where water is sucked up into a kind of water tower. On a given signal, the “accumulated water volume” is released and the pipeline or recipient system is cleaned out. These systems are very suitable for topographically flat areas. The extent to which they will become more widely used in Denmark can only be the subject of guesswork.

The simple version of vacuum cleaning consists of lightly flushing the sewer line by feeding water into an upstream manhole so that by gravitation the water, to a certain extent, cleans out the sewer downstream of the vacuum system.

The three last mentioned methods are described in the following sections since these are regarded as being the most widely used.

High-pressure flushing

High-pressure flushing is the most widely used cleaning method for public sewerage systems. It employs water subjected to pressure from a pump. The water is then pumped through hoses to a flushing head attached to the hose end. The water pressure can be varied to suit the type of project, but 30-200 bar is quite normal. With industrial flushing the pressure can be much higher, easily up to 800 bar.

The flushing hose is propelled along the line to its “starting position” by a water jet sent backwards by the flushing head. When the flus-



High-pressure flushing vehicle.

hing head reaches this position, the necessary pressure is supplied to the hose and it is hauled back towards the point where it was inserted. In this way deposits are drawn back towards the insertion point. Cleaning will thus always start upstream and proceed towards the downstream well so that the force of gravity does not have to be overcome. However, traffic conditions, private ground, buildings and other features do sometimes mean that cleaning has to be performed in the opposite direction.

High-pressure flushing can be used primarily to remove loose debris, but is to a certain degree also effective against more permanent accumulations. Normally, flushed material is collected in a sludge tank which is usually an integral part of the high-pressure flushing vehicle.

Root cutting

Tree roots often appear in underground pipes and can cause operational problems. Typically, trees with deep roots are the cause, e.g. willow, poplar, and birch, all of which have very extensive root systems.

Smaller roots can be removed by high-pressure flushing - the jets themselves cut the roots. This method is used when lines "only" need a general clean-out. When the sole task is to cut tree roots, the preferred method is mechanical root cutting.

Mechanical root cutting is performed by a purpose-built machine which can be attached to the hose from the high-pressure flushing vehicle – from where it is controlled.

Chain cutters are the most widespread implements for removing tree roots, but knives and other devices can also be seen. It is very important that the root cutting implement matches the size of pipe very precisely so that it does not damage the pipe or itself when used. For this reason mechanical root cutters are normally equipped with guide bars to ensure that they run centrally through the pipe.

A root cutter.



Cleaning pig

With pressure cleaning it is also possible to use a “cleaning pig”. This device is made of moulded foam rubber, plastic, etc. and is also used in water supply lines.

The cleaning pig should be inserted into the pressure line, as close to the pumps as possible. A pig catch net is inserted in the pressure well.

Cleaned-out debris

Before a contractor’s quotation for cleaning is accepted, the pipeline owner should also make clear how cleaned out debris is to be treated.

The reason is that there might be a large difference between the charges levied on the disposition of material from rainwater and wastewater.

The need for cleaning most often arises because of operational problems in the sewers from,

Cleaning pigs



The cleaning pig is forced through the pressure pipeline, thus loosening deposits which are pushed on through the system.

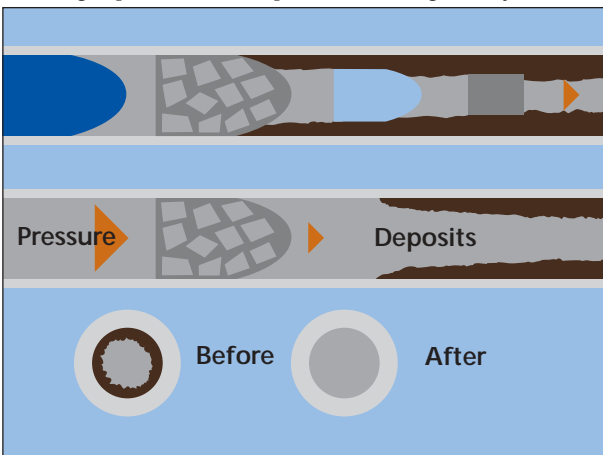

for example, large accumulations of sand and consequent blockage downstream, discharge of debris to a downstream recipient, the separation of oil/fat/roots, smell nuisance, etc.

7.3 Implementation

Before the contractor actually starts the cleaning task, there are a number of points that need examining first. An assessment should be made to confirm whether:

- A clear description of the task has been prepared
- Information about the work and its effect has been issued to residents likely to be affected
- The personnel chosen for the job have the ability to carry it out
- The flushing equipment chosen is suitable for the cleaning task
- Necessary barrier equipment is carried in the vehicle

In particular, the pipeline owner should ensure that the chosen contractor has the required equipment and that the appointed personnel are capable of carrying out the work. In other words, pipeline owners should be far more precise in making demands on and describing requirements to flushing contractors.

Flushing equipment

In this section, high-pressure flushing vehicles are described as these are the most widespread within pipeline cleaning.

Flushing vehicle

Three main types of vehicle are available today:

- Separate flushing vehicle
- Flushing vehicle and sludge extractor (combination vehicle)
- Recycling vehicle with sludge extractor

Flushing vehicles are, typically, used for tasks on private property where blockages occur in service lines, waste pipes, etc. In such cases it is seldom necessary to suck loosened material from lines. As its name implies, the flushing vehicle is able to flush-clean the lines and is therefore ideal for such tasks.

Flushing vehicles with sludge extractor or combination vehicles are the most common types in Denmark. They are used for cleaning both main and service lines, etc. They are equipped with a high-pressure pump for flushing and a vacuum pump for sludge extraction.

Recycling vehicles have become more widespread in Denmark in recent years. These vehicles suck the flushing water from the line and recycle it. They are ideal for tasks where large quantities of water are necessary, e.g. large mains. Like combination vehicles, recycling vehicles are equipped with both a high-pressure pump and a vacuum pump.

Flushing head

The flushing head can be compared to the shovel on an excavating machine where different sizes must be used, depending on the nature of the work.

There are three main types of flushing heads:

- Conventional flushing heads
- Flushing heads with cone
- Flushing heads with tubing

In conventional flushing heads, the water flow is not channelled, but “finds” its own way out to the orifices. In the other two types the water is channelled to the orifices.

Swedish trials have shown that the cleaning effect is greatest when the water jets do not emerge in drop form (atomised). Therefore the choice of water pressure, form of flushing head and orifices are closely related when a task has to be planned. Thus, in flushing head 1, the pressure drop is high when the water flow is not channelled, whereas with the two other heads the pressure drop is much less because the water is channelled to the orifices.

Three types of flushing heads.



Flushing hoses

To clean lines in the best possible way, the water quantity and hose dimensions (including length) must be chosen to suit the actual task. The criteria below are given as guidelines for determining different pipe dimensions.

Generally speaking, there are three types of hoses: plastic, rubber and metal-reinforced hydraulic hose. The hydraulic hose is heavy, electrically conductive and the reinforcement easily becomes frayed, carrying with it the risk of skin damage and infection as far as operating personnel are concerned.

Plastic hoses are lighter, but more rigid than rubber hoses (which are also heavier). Plastic and rubber hoses are the most used in Denmark.

Hose diameter	Pump l/min	Pipe dimension
1/2"	60	op til 160 mm
3/4"	175	op til 300 mm
1"	300	op til 600 mm
1 1/4"	400	op til 900 mm
1 1/4"	500	op til 1000 mm

The water pressure is most often measured using a pressure gauge mounted close to the pump. As indicated under the section “Flushing head”, however, it is the water pressure at the flushing head which is important. To calculate this water pressure, the pressure drop occurring between pressure gauge and flushing head must be subtracted from the gauge reading. That is to say, hoses and fittings are typical sources of pressure drop.

If the pipeline owner sets requirements for the flushing equipment to be used – regardless of the problems this might mean for the contractor in changing hoses or the flushing/pressure head – several benefits can be achieved: water consumption can be reduced, and overpressure/underpressure accidents in service lines can be avoided, thus reducing the number of discontented users.

For the contractor, the lower water pressure, the “correct” choice of hose dimension and water quantity in relation to the equipment means less wear, fewer replacements, and hopefully, better and cheaper cleaning results for everyone.

Flushing personnel experience

When planning flushing operations and assigning personnel, the pipeline owner should pay special attention to the following:

Training

At the moment, there are no recognised training courses for flushing operators in Denmark. New operators are typically “under the wing” of more experienced personnel.

Information Note no. 4.04.18 issued by the Danish Working Environment Service, “Working with high-pressure cleaning equipment” (Arbejde med højtryksrensning) (see references), stipulates that operating personnel must:

- have good knowledge of the equipment, the safety aspects, and how it should be maintained
- be well informed about safety and health precautions that must be taken with the equipment
- have adopted a work technique that in the best way possible prevents accidents and health hazards while work is proceeding

Employers are therefore obliged to ensure that flushing operators are proficient and able to fulfil these requirements.

It can thus be seen that to be able to clean sewer lines and achieve the required level of quality, personnel must have gained knowledge and experience of all aspects, including materials, the work itself, safety, the work environment, sewer construction, and the associated laws and statutory orders.

In this industrial category it is not unusual to see one-man companies, i.e. where one man is the employer and the operator, and this might be a problem where the implications of such knowledge and experience are concerned.

The obvious conclusion is, then, that as soon as possible it would be desirable to establish training courses for existing and new operators, and administrative staff. It is in this way that sewer lines could be cleaned more safely, to the benefit of operators, the sewer lines themselves, and the environment.

Safety and health

There are many factors within sewer line cleaning by high-pressure flushing that can create unforeseen circumstances for the operator and for the near surroundings. Some of these factors can be put down to human error, others to incorrect or

deficient equipment, poor maintenance or planning.

As at the moment there are no proper courses on the subject, it is not surprising that the associated rules and statutory orders that do exist are perhaps not fully known by the companies carrying out this type of work.

For this reason, the most used paragraphs of the Danish Statutory Order on Sewers and the previously mentioned Information Note are briefly dealt with in the following sections. The CEN Technical Committee has just submitted a standard for hearing in this industrial category, but as yet no answer has been received and therefore it cannot be discussed here.

The Danish Statutory Order on Sewers (“Bekendtgørelse om kloakarbejde m.v.”)

Statutory Order no. 473 of 7 October 1983 issued by The Danish Working Environment Service as amended by Statutory Order no. 9 of 14 January 1988 (“Bekendtgørelse om ændring af bekendtgørelse om kloakarbejde m.v.”) (see references) deals with a number of requirements on, for example, the site arrangement, auxiliary equipment, the work itself, protective apparel and welfare measures.

As regards the site, and as far as it is possible, high-pressure flushing must be performed from the terrain. Climbing down into a sewer pipe is only permitted when pipes are 120 cm or more (although dispensations have been granted for pipes down to 80 cm). Working in pipes might be necessary, for example, when debris becomes permanently lodged, or there are pipe fragments, bricks, etc. that cannot be removed by high-pressure flushing. However, according to regulations, descent into a manhole or sewer pipe is allowed only when the need for physical presence could not have been foreseen. In addition, personnel cannot be permitted to be in the manhole or sewer pipe for more than 5 minutes.

In the event of the need for physical work in sewers, measuring equipment must be provided to register the presence of various gases, as well as a hoist and a watchman. If the work is expected to involve personnel being in the sewer for more than 5 minutes, stricter safety regulations come into force, such as the need for extra watch personnel and mechanical ventilation if the existing means of ventilation is considered or found to be inadequate.

According to the section on auxiliary equipment, for dangerous remotely controlled machi-

nery there must be an emergency stop device in the immediate vicinity of the machinery. Furthermore, personnel must not come into direct contact with extracted substances nor be subjected to hazards such as aerosols or toxic fumes/gases.

There are also requirements in connection with protective apparel. For example, special clothing and sometimes masks are stipulated if the backwash of flushing water contaminated with harmful bacteria cannot be avoided or if flushing cannot be performed from the terrain. The regulations also contain instructions on how workwear and personal protective apparel are to be stored, handled, and washed.

The requirements laid down by The Danish Working Environment Service in connection with personnel welfare (canteen, changing room, showers, etc.) must also be observed.

Employers are responsible for ensuring that these regulations are observed. Failure to do so is punishable by law.

Working with high-pressure cleaning equipment – (“Arbejde med højtryksrens anlæg”) In Information Note no. 4.04.18, October 1990, (“Working with high-pressure cleaning equipment”) (see references) some of the regulations are more precise and stricter versions of those contained in the Statutory Order on Sewers.

For example, “high-pressure equipment” means plant where the pressure is higher than 25 bar and plant in which the pressure exceeds 70 bar may only be operated by persons of 18 years of age or older, unless such operation is part of a training course or similar sequence of instruction.

Regulations require a two-hand grip on flushing nozzles and similar, ergonomic strain avoidance measures, footwear with non-slip soles, and so on. If plant includes an internal combustion engine in confined spaces, there must be an effective exhaust gas extraction system.

The Information Note stipulates the use of waterproof gloves and an apron or coverall, whereas the Statutory Order on Sewers only requires such equipment when personnel are to enter a sewer line. The use of ear protectors is also required when the noise load exceeds 85 dB(A). Eye protection against aerosols and liquid splashes is also obligatory.

A further section in the Information Note deals with the extent of inhouse training and instruction in the use of equipment, and stipulates that the employer is responsible for providing such facilities.

High-pressure cleaning plant must of course be inspected, maintained, and be in good operating condition. This means that worn or defective parts must be replaced and that the maker's instructions must be followed.

Finally, the flushing contractor is responsible for providing the necessary signs, barriers, marking, etc.

Documentation of work carried out

The pipeline owner should ensure that all cleaning work is the subject of some kind of reporting system in order to confirm that work has been carried out thoroughly.

The pipeline owner should also prepare a flushing schedule and go through it with the flushing contractor, simply because the requirements imposed by different pipeline owners are not always the same:

- Date, operator, equipment and other basic information
- Estimated quantity of sand and stone flushed from the line(s)
- Location of blockages
- Other information

Of course, situations may arise which the flushing schedule cannot cover, but of which the pipeline owner must be made aware. These can be noted in a logbook or a deviation report which may contain such information as:

- Map deviations
- Pipe connection errors
- Fallback
- Special conditions, such as infiltration, bad smells from sludge, contamination, gurgling, etc.
- Information given to the operator by residents in the area

While the work is proceeding it is most certainly advantageous to hold a site meeting in order to collect registered information, particularly that of a special character. In this way the pipeline owner is able to see what actions should be initiated. For example, in the case of observed pollution, the person responsible for the discharge could be informed and asked to do something about the problem.

In the same way, there ought to be a contract completion/commissioning meeting at which the project is reviewed.

7.4 Cleaning water pipelines

The cleaning of sewer lines has been described in detail in the previous sections. However, it is also necessary to describe the cleaning of water pipelines as this must also be performed periodically.

In general, the same cleaning methods may be used for water pipelines as for sewer lines.

However, the cleaning method used depends on the size and function of the water pipeline; a distinction is made between pipelines for unfiltered water, water mains, supply lines, and service lines.

The water extracted from Danish aquifers contains, among other things, iron and manganese (ochre), and calcium and magnesium (lime deposits). In pipelines used for unfiltered water, these minerals are deposited as a soft, slippery sediment.

Some types of water form hard deposits even at low oxygen concentrations and where turbulence occurs.

In pipelines used for filtered water, deposits occur in the form of incrustation, i.e. a hard, lumpy coating consisting of iron and lime. Incrustation occurs particularly in graphite grey iron pipes used for hard water.

It is also important to consider the use to which the pipeline will be put after cleaning. Moreover, the material the pipeline is made of must be taken into account as individual cleaning methods may have different consequences and effects depending on whether they are used in pipes made of PVC or cast iron.

Furthermore, before cleaning water pipelines, several factors in particular should be considered:

- The inside surfaces of old cast-iron pipes are often encrusted with hard deposits of iron and lime that may be difficult to remove effectively with a cleaning pig
- High-pressure flushing, with pressures up to 1000 bar, is a particularly effective cleaning method, which can remove all deposits from the pipeline. It should, however, be noted that if the method is used for graphite cast-iron pipes, the pipeline must be renovated after cleaning because such high pressures damages the pipe, with the risk of subsequent leaks
- All deposits should be completely removed before renovating a pipeline with PE pipes in order to prevent them from being damaged during insertion into the existing pipeline
- If deposits are to be removed from old cast-iron pipelines solely to improve their hydraulic properties, the use of a cleaning pig or mechanical cleaning is recommended

- Unless cast-iron pipelines are coated internally after cleaning, with for example cement mortar or epoxy resin, the deposits will reform within a few years.

It should be noted that the inside surface of graphite grey iron pipes have greatly reduced adhesiveness

The cleaning methods mentioned above will be described in more detail in the following sections.

Cleaning with high-pressure flushing

A rotating flushing head centred in the pipeline, is pulled through the pipeline at a constant speed using a winch.

The speed at which the equipment is pulled through the pipeline and the angle at which the water jet strikes the pipe wall are important for the result achieved. The quantity of water consumed varies from 50 to 175 l/min under variable pressures of between 1000 and 1500 bar.

The cleaning unit should advance at speeds of about 30-50 cm/min depending on pipeline diameter.

In some cases, particularly for bitumen-lined pipelines, costs in connection with the disposal of the water used for cleaning can be expected.

The method described removes without difficulty ochre deposits, other mineral scale, and rust. The method is suitable for cleaning pipelines prior to their renovation with PE pipes in order to protect the pipes from becoming damaged during installation.

The purpose of high-pressure flushing is to obtain a clean pipe wall and maintain complete pipeline cross-sectional areas.

A method for cleaning pipelines similar to that described above is root cutting, in which deposits are dislodged from the inside surface of the pipeline using rotating chains in combination with water at a pressure of 125-150 bar. Depending on the renovation method to be used, conventional flushing can subsequently be performed to achieve complete cleaning of the pipeline.

Cleaning pigs

Cleaning pigs can be driven through the pipeline by water or compressed air. Pigs are designed as flexible, bullet-shaped, foam-rubber cylinders with concave pressure faces. Sturdy spiral ribs of urethane rubber are attached to the surface of the cylinder. It is these ribs, which may also have steel studs or brushes attached, that provide the cleaning effect.

In the actual cleaning process, an oversized pig is inserted into the pipeline. The pressure that is then applied behind the pig to drive it through the pipeline creates friction between the pig and the pipe wall.

When pressure is applied from behind, the cylindrical body and urethane ribs are compressed lengthwise and expand radially, just like a wedge.

When pressure is applied behind the pig, high-pressure low-volume jets are created between the pig and the pipe wall. These jets provide the cleaning effect. Deposits are "flushed" from the pipe wall and debris is pushed forward in front of the pig.

The purpose of cleaning pigs is to remove loose sediments, improve water flow and remove iron oxide (ochre deposits), lime and barium sulphide.

The inside surface of the pipeline is thoroughly cleaned, and cleaning pigs therefore provide a suitable method for use prior to renovating pipelines with PE pipes using sliplining techniques. The method is also used in the regular maintenance of large transport pipelines to prevent excessive sedimentation. Improved flow and complete cross-sectional area are achieved.

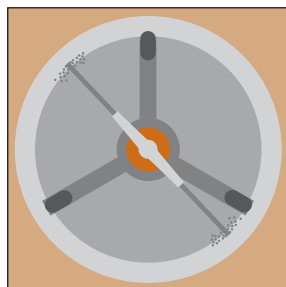

Cleaning with scraping tools

Cleaning is performed by pulling circular wire brushes and/or spring-steel devices through the pipeline. A winch cable is fed through the pipeline to be cleaned and the cleaning tools winched back through the pipeline. The circular brushes are oversized and are thus pressed firmly against the pipe walls while being pulled through the pipeline. Deposits are thus brushed from the walls and pulled out of the pipeline together with the brush. Cleaning is accomplished without the use of water. Where there are large quantities of deposits, these can collect and block the pipeline so that the cleaning unit cannot be pulled forward.

The purpose of cleaning and scraping tools is to remove loose sediments, improve water flow, and remove iron oxide (ochre deposits), lime and barium sulphide.

The inside surface of the pipeline is well cleaned. The method is therefore suitable for use prior to renovation with PE pipes, etc.

Schematic illustration of pipeline cleaning using a scraping tool.

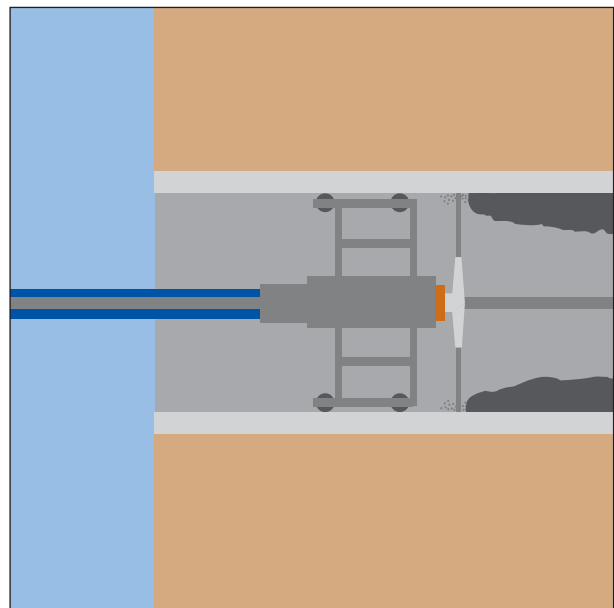

CLEANING PIPELINES

7

METHODS

8.1 Introduction

For many years now, lining with cured-in-place pipes (CIPP) has been a well-established technique and a recognised alternative to conventional open-cut methods in Scandinavian countries, not least because of quality assurance work carried out in the individual countries and the control scheme established in Denmark.

Innumerable cables and pipes are buried in the ground. The installation of pipeline systems for distributing water and gas and for draining rain-water and sewage was started in the middle of the 19th century.

As a result of the natural deterioration of pipes and the ever-increasing demands made on them, pipelines are currently undergoing large-scale rehabilitation. In Denmark, the systematic inspection and renovation of pipelines is mostly concerned with sewers.

Pipeline renovation using CIPP was invented by Peter Wood in 1972, and used in Scandinavia for the first time in the mid 1970s. Subsequently, the methods, including the materials used, underwent further development throughout the 1980s and 1990s.

What is CIPP?

CIPP is known as "strømpeforing" in Danish and as "flexibla foder" in Swedish.

According to the technical regulations, CIPP is defined as "products or systems based on fabric impregnated with resin that only become self-supporting pipes after installation and curing".

All CIPP products are made of felt or fibreglass impregnated with a synthetic resin which, depending on use, can be a polyester or epoxy compound or some other material.

Homogeneous and non-homogeneous liners are available. Homogeneous liners are made of the same type of felt and synthetic resin throughout, while non-homogeneous liners have a supportive reinforcing layer as well as a resin-impregnated layer. The reinforcing layer is usually made of fibreglass. The wall thickness used for both homogeneous and non-homogeneous liners is determined in individual cases by the condition of the pipeline to be renovated.

Non-homogeneous liners made of a fibreglass laminate have a higher modulus of elasticity and thus a thinner wall.

This chapter on CIPP is primarily based on information contained in the specifications of products currently participating in the Danish control scheme.

At present, similar control schemes do not exist in the other Nordic countries, but the suppliers covered by the Danish control scheme are by and large the same companies that supply the other Nordic countries. Common for all companies participating in the Danish control scheme is that the liner they use is supplied by a liner manufacturer. The company that manufactures the liner may be owned by the contractor or may merely supply impregnated liners to one or more contractors in the various countries.

The design of cured-in-place liners
Homogeneous liners consist of a felt tube impregnated with synthetic resin. The purpose of the felt tube is merely to retain the resin and it plays no role in the final strength of the product.

The tube consists of 1–7 layers of felt, each joined with a longitudinal seam. To ensure a uniform laminate, the seams of successive layers are staggered. The outermost layer of felt (which forms the inside surface of the finished pipe) is coated with a layer of PU, PE or PP.

Depending on the supplier, non-homogeneous liners consist of either a diagonally woven layer of felt or a laminate of various types of fibreglass. Using fibreglass provides the liner with reinforcement. The fibreglass used can be E or ECR fibreglass. E fibreglass is not resistant to chemicals and is therefore not suitable for aggressive wastewater. ECR fibreglass on the other hand is resistant to chemicals and can therefore be used for all kinds of wastewater.

The type of resin used is selected on the basis of customer information on temperature and chemical conditions in the host pipe. The following main types are used:

- Polyester resins – used for ordinary sewer lines
- Epoxy resins – used when heat and chemical resistance is required
- Vinyl ester resins – used when outstanding heat and chemical resistance is required

There are several variants of all these main resin types, providing properties suitable for special applications.

8.2 Applications

It is important to choose the best renovation method for each individual project. The available space, the chemical composition of the fluid carried by the pipeline, the pressure and temperature in the pipeline, the number of laterals, the number of manholes, etc. must be assessed from project to project.

The following table provides an overview of CIPP applications and possible limitations.

Pipeline type	Suitable	Comments
Sewers	✓	
Gas pipelines	-	
Potable water pipelines	✓	(see note A)
Chemical/industrial pipelines	✓	(see note B)
Straight pipelines	✓	
Pipelines with bends	✓	(see note C)
Circular pipes	✓	
Non-circular pipes	✓	(see note D)
Pipelines with varying cross-section	✓	(see note E)
Pipelines with lateral connections	✓	(see note F)
Pipelines with deformation	✓	(see note G)
Pressure pipelines	✓	(see note H)

- (A) The Phoenix lining system is approved for lining potable water pipelines and can be combined with other lining systems to provide sufficient strength.
- (B) As each manufacturer uses different types of resin, reinforcement, etc., the chemical resistance of liners varies from supplier to supplier. However, all systems using felt impregnated with polyester resin or ECR fibreglass reinforcement are suitable for aggressive wastewater. If special characteristics are required, individual manufacturers should be contacted in order to help finding the most suitable product for specific requirements with regard to chemical content, concentration, temperature, etc.
- (C) The possibility of negotiating bends depends on the installation and curing processes of the various systems. Liners that are inverted during insertion can usually negotiate bends up to 90°. There are, however limitations to the degree of bending that UV-cured liners can manage. Bends can also present problems for liners that are pulled into place because

the liner must remain on the underlying protective foil and must under no circumstance become twisted. It is important to be aware that vertical creases may occur in the liner when negotiating sharp bends.

- (D) All the described methods are suitable for lining main pipelines with circular, egg-shaped or V-shaped cross sections.
- (E) Some proprietary liner systems allow CIPP techniques to be used in pipelines with varying cross-sectional area.
- (F) Laterals can be reinstated using a robotic cutter. It is presently possible to re-open laterals on pipelines with a diameter of more than 100 mm. In man-entry systems, laterals are re-opened manually. With some CIPP systems, watertight connectors can be fitted between laterals and main lines.
- (G) CIPP can be used where deformities are minor. For major deformities, localised repair using tunnelling techniques or excavation should be carried out prior to lining.
- (H) A few liner manufacturers can supply laminates suitable for pressure pipelines.

Dimensions and maximum lengths

Liners cured with water can have diameters of 100 mm to 2000 mm and lengths of up to 600 metres.

Liners cured with steam can have diameters of 50 mm to approx. 600 mm and lengths of up to 150 metres.

Liners cured with UV light can have diameters of 150 mm to 900 mm and lengths of up to 200 metres.

Liners that are pulled into place can have diameters of 100 mm to 1250 mm and lengths of up to 200 metres.

Localised repair

Localised repair is performed with a wide range of systems. The systems fall into the following two main categories depending on the diameter of the pipe to be repaired:

- For pipe diameters from 150 mm to approx. 600 mm, repairs are carried out by remote-controlled equipment inside the pipe
- For pipe diameters larger than approx. 600 mm, repairs are carried out manually from inside the pipe

Liners used for localised repair are generally the same CIPP products as those used for ordinary pipeline renovation.

Localised repairs are not presently covered by the Danish control scheme. The market is characterised by a wide range of suppliers and systems. For all of these systems, wall thickness is difficult to calculate, their service life is unknown and the tightness of their connection to existing pipes is doubtful. Localised repair must be considered as repair and not as NO-DIG renovation, for which pipeline owners can expect a service life similar to that of new installations. In addition, localised repair limits the work that can be done on the pipe at a later date. Some localised repairs greatly reduce pipe diameter and cause creases in subsequently installed liners.

Environmental conditions at the workplace

It is the responsibility of individual contractors to comply with current legislation on the work environment. The authorities are especially vigilant regarding possible work environment problems relating to the renovation of sewer systems.

Examples of the aspects that must be covered are:

- Workplace evaluations
- Safety organisation
- Health and safety plans
- Safety measures
- Safety equipment
- Welfare measures
- Personal hygiene
- Emergency plans

Cured-in-place lining



It should also be borne in mind that in addition to national legislation, local authorities can lay down rules and regulations for many aspects of the work environment.

Environmental aspects of CIPP products

Product specifications should be used to ensure that the chosen product is suitable for the renovation in question. For example, greater demands are made on potable water pipelines than on sewer lines. In this case, it is important to ensure that all product information and approvals required by the authorities are available.

8.3 Preliminary surveying

To achieve the best possible result of pipeline renovation using CIPP techniques, it is important to carry out detailed preliminary surveying to determine, at the very least, the following:

- The condition of the existing pipeline – using closed circuit television (CCTV) inspection
- The need for cleaning – using CCTV inspection
- Pipeline length and depth
- Pipeline dimensions, deformities, displaced joints and bends
- Water table depth
- Location of laterals
- Traffic load
- Lateral data – including dimensions, unused service lines, used service lines and intruding service line connections
- Manhole condition



Installation under difficult conditions.

8.4 Preparatory work

Once necessary preliminary surveying has been completed and renovation is about to commence, there are several routines for the way in which preparatory work should be carried out in order to achieve effective pipeline renovation.

These include:

- Any planned overpumping, its duration and the number of consumers affected
- Planned traffic diversions and their advertising
- Pipeline shutoff (timing, duration, number of laterals affected)

Usually, the preparatory work required depends on what the pipeline is designed to carry. For a sewer, for example, preparatory work would include:

- Inspection and possible grinding of intruding service line connections, pipe sections and displaced joints on the existing pipeline
- Inspection and possible grinding or cutting away of scattered deposits
- Water jetting/root cutting
- Closing/blocking off unused service lines
- Restoration of the existing pipeline or parts of it when badly deformed

Design criteria

In Denmark, specifications for cured-in-place pipes used in renovation work under the Danish Control Scheme for Pipeline Rehabilitation

(Kontrolordning for ledningsrenovering) are calculated in accordance with the current edition of Static Design Criteria for Rehabilitating Sewer Lines (Gravity Sewers) (Statisk dimensionering ved fornyelse af afløbsledninger (gravitationsledninger)), published by the Danish Contractor's Association (see references).

The material parameters of each product are determined using continuous process control as stipulated in technical guidelines under the control scheme. The material parameters are therefore correlated to the partial coefficients laid down in the guidelines for design criteria equivalent to the requirements set by DS 409.

The pipeline owner shall, in connection with design criteria calculation, provide information on whether the cured-in-place liner is to be designed as an unsupported pipe (i.e. for laying in peat or mud) or a pipe with side support (i.e. for laying in soil). In addition, information should be provided on the depth of the water table if this is known, and on whether the pipeline must be able to withstand vertical loads from the ground or above-ground traffic. Procedures for providing such information are given in the design criteria guidelines. As material parameters vary from product to product, the wall thickness of the various liners will differ despite their design being determined on the same assumptions. A homogeneous, tough product with a low modulus of elasticity will thus be thicker than a brittle product containing fibreglass.

Installation using water inversion and hot-water curing.

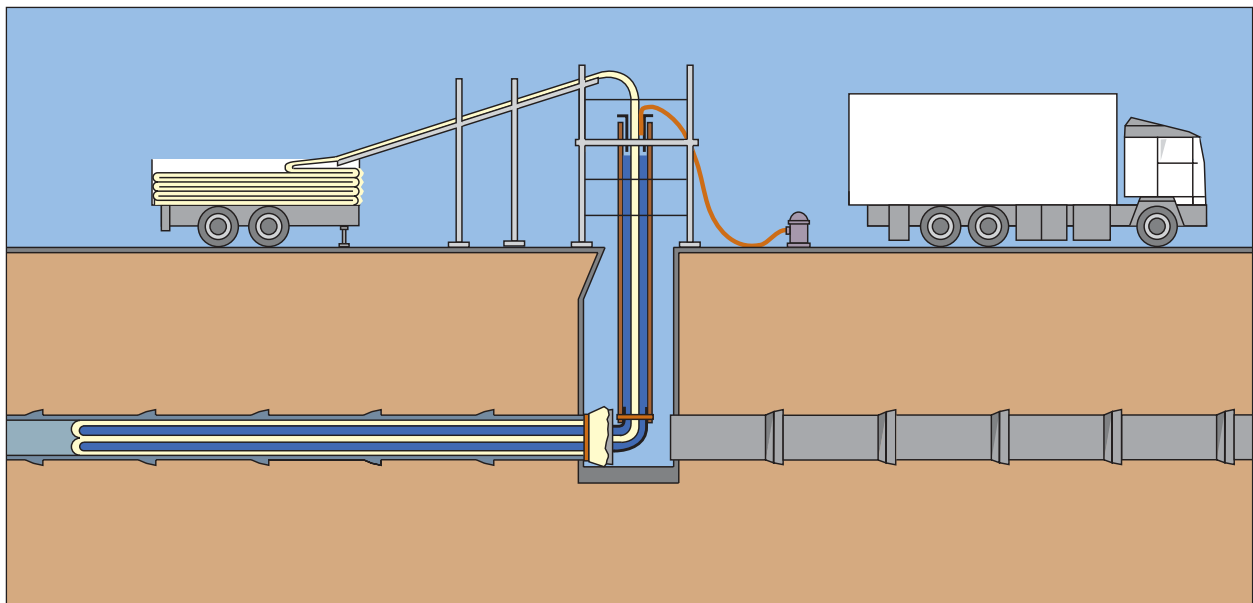

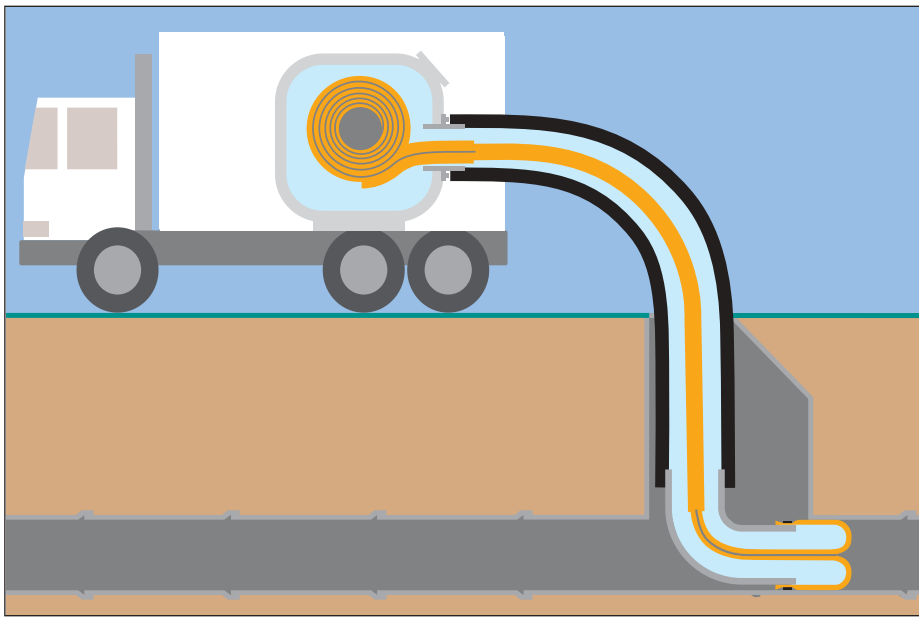

Installation using compressed-air inversion and steam curing

In Sweden, design criteria are determined in accordance with VAV P66, which stipulates that the pipeline owner shall provide information on the pipeline diameter and depth, ground-water pressure, traffic load and deformation. In addition, the pipeline owner shall provide details of safety factors and the tangent modulus of the soil.

Pipeline design criteria should then be determined in accordance with load rating A or B. The calculation of A is based on upheaval buckling due to ground water, and calculation of B is based on the pipeline being self-supporting.

In Norway, it is usual for the pipeline owner to state which SN rating (ring stiffness) is required for the finished product. The liner must also be self-supporting and free from creases and wrinkles in deformed sections of the host pipe.

8.5 Installation

Cured-in-place pipes are installed either by inverting them into the pipeline using water pressure or compressed air, or by towing them into the pipeline with a winch.

Water inversion

Water inversion is the oldest method, and can be used for pipes with a diameter of up to 400 mm. The tube is inverted over an inversion head located at the pipe opening in the manhole. The inversion head is fitted to an inversion standpipe, which provides the head of water necessary to invert the liner into the host pipe.

For pipes with larger diameters, the tube is inverted from the top of the inversion standpipe. A

cable is attached to the foremost end of the tube to guide it and ensure correct inversion into the pipeline. Strengthening strips are sand-wiched between the layers of the laminate to prevent longitudinal stretching during installation. There are no limits to dimensions when using water inversion.

Compressed air inversion

Compressed air inversion techniques differ depending on which curing method is to be used. If the liner is to be cured with steam, it is inverted into the host pipe via an inversion head and the liner is forced into the host pipe using compressed air. A guide cable is also attached. When the liner is in place, pressure is released and the compressed air replaced by steam for curing.

If the liner is to be cured with UV light, installation is accomplished from a lorry containing the liner positioned above the launch pit. The liner is fitted to a launching device that is lowered into the pit. Mobile installation equipment is used if the lorry cannot be positioned above the pit. The liner is inverted into the pipe using compressed air and guide cable, the air pressure and speed of advance being controlled the whole time. Once the liner is in place, the compressed air pressure is maintained while the UV light source is fitted.

Water inversion, and to a certain extent compressed air inversion, ensure that any water collected in pipelines with structural irregularities is forced out and that the pipeline is not damaged in any way during installation.

Winched insertion

Liners are pulled into place on a protective foil. The purpose of the foil is to prevent the liner from being damaged when it is dragged over cracks, fractures, corroded sections of pipe, etc. and to reduce friction. There is a risk that loose pipe fragments will become dislodged when the foil and liner are winched into the pipe.

Winched insertion has limitations with regard to pipe diameter and length. The laminate design prevents the liner from being torn apart during installation.

Curing with water

Hot water is the oldest method of curing cured-in-place pipes.

The curing process can be documented and continuous registration of water temperature ensures correct laminate curing. It is also possible to control laminate cooling so that tensile stress in the material can be minimised.

Curing with water allows long runs of large-diameter piping to be lined.

The main drawbacks are that the process is relatively slow and that water used for curing is wasted. It is also necessary to consider the recipient of the large quantities of water used during lining.

Curing with steam

Curing with steam has been in use since the beginning of the 1990s. The main benefit of the method is that curing occurs rapidly. The method has the following disadvantages:

- It can be difficult to control the steam supply and the liner may therefore "boil"
- Cooling occurs suddenly, increasing the tensile stress in the laminate
- It is difficult to check that the laminate is thoroughly cured, and it can be also be difficult to ensure complete curing in pipe sections containing structural irregularities or where ground water infiltrates the pipe
- When lining pipes of limited gradient or pipes with structural irregularities, it is important to be aware of the fact that "puddles" of condensation can cause insufficient curing

Curing with UV light

Curing with UV light has been used since the early 1980s. The method provides rapid curing and is simple to control. The curing process is controlled and documented by continuous registration of air pressure, laminate temperature, UV lamp output/light intensity, and curing rate.

With UV curing, cooling occurs continuously as the UV light source gradually passes through the pipe thus reducing tensile stress in the liner.

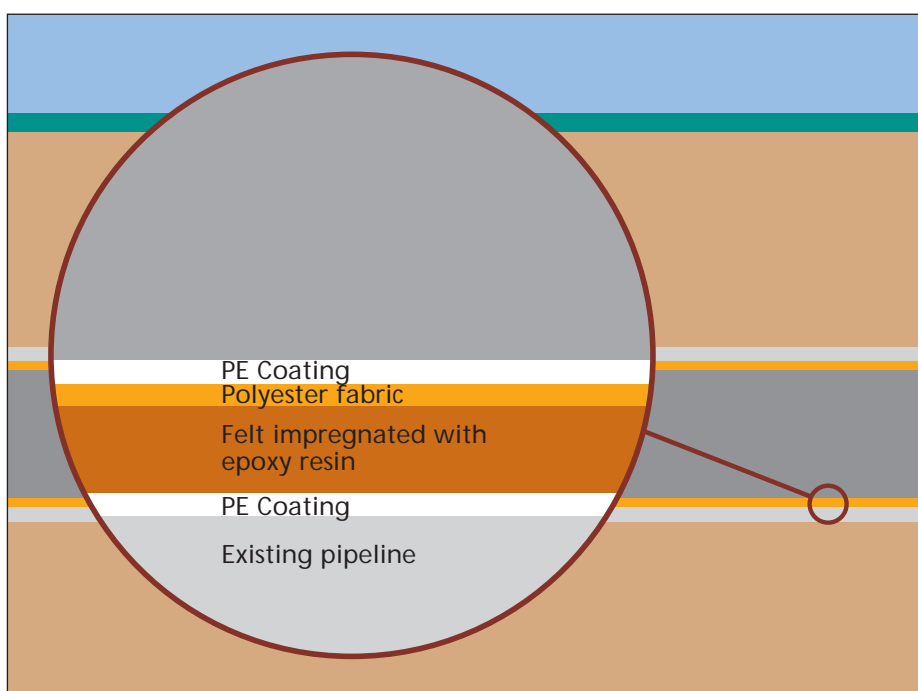

Magnified structure of a cured-in-place lining

Common faults in connection with cured-in-place lining

Usually, nothing goes wrong, but in rare cases the following faults and defects may occur.

Longitudinal creases typically occur when the diameter of the liner is larger than the diameter of the pipe being renovated. This commonly occurs when a tapered section has been inserted into the existing pipe which reduces its diameter. Such tapered pipes often go unnoticed by CCTV operators:

- Soft, uncured sections typically occur if the resin is washed out by high levels of infiltration or if the outer surface of the existing pipe is subjected to low temperature and thus cooled. They can also be caused by rips or holes in the outer foil coating. Such soft, uncured sections buckle
- Cracks around the circumference of the liner occur occasionally in otherwise problemfree runs. The cracks appear where the liner does not bond with the existing pipe in open connections, bends, cracks, fractures, etc. and are caused solely by liner shrinkage during and after curing
- Liner blistering or "boiling" occurs when steam is applied prematurely at excessive temperatures

8.6 Completion work

After installation, it is often necessary to carry out completion work. This may, for example, take the form of the following:

- Leak testing
- Consumer information following service line reinstatement
- Manhole finishing to ensure continued smooth flow
- Service line reinstatement so that wastewater from individual consumers can again be lead to the main sewer
- Final CCTV inspection to document the completed renovation

The purpose of completion work is to ensure that tasks over and above actual pipeline renovation are performed and documented in accordance with the contractor's own quality requirements and to the satisfaction of the pipeline owner.

8.7 Quality assurance and documentation

A final review compares the documented work performed with the requirements and descriptions of the contractor and any supervising authorities. A final review should always be conducted, its purpose being to confirm that work done is in compliance with agreements made.

When a renovation project is completed, the contractor provides the pipeline owner with documentation of the quality of the work performed in the form of a quality manual. In this respect, it is important that during the tendering phase the pipeline owner ensures that such documentation can be prepared and submitted on completion of the renovation work. The quality manual should at least contain or state the following:

- Declaration stating which products/installation methods have been used
- How preparatory work and preliminary surveying have been performed
- Materials handling
- Availability and use of installation manuals
- How supplementary work and final quality assurance have been carried out and documented
- The form of final documentation
- How deviations in relation to the instruction manual have been dealt with
- Complaint processing
- Effect of materials on the environment

9.1 Introduction

Over the years, many short-pipe systems have been used for sliplining. Both rigid and flexible pipes have been used, including pipes made of concrete, clay, steel, GAP, PE and PVC. Numerous short-pipe systems for sliplining were developed in the 1980s, many of which had very complex mechanisms for connecting the pipe to laterals and manholes. Now, at the beginning of the 21st century, there are very few short-pipe systems remaining on the European market. The main reasons for this decline are problems concerning the many connections and difficulties during installation.

The pipe material most commonly used at present for sliplining is polyethylene (PE), a material approved for use in the potable water, sewerage and gas industries. It is hard-wearing, flexible and highly resistant to outside influences, including aggressive soil conditions and chemicals.

In short, sliplining is nowadays predominantly a renovation method in which long, welded PE pipe sections are inserted into the pipeline to be renovated. Sliplining is mostly used for pressure pipelines.

What is sliplining?

Sliplining is the simplest technique for renovating pipelines. During the sliplining process, a new liner is pushed or pulled into the host pipe. The idea of inserting new pipes into existing "tunnels" is not new, and there are reports of clay pipes being pulled into old sewers and culverts many decades ago.

As a renovation method, sliplining does not require investment in costly specialised equipment, and standard pipes and fittings are used. The most important limitation of sliplining is the reduction in pipe diameter inherent in the system. It is therefore necessary to establish whether the use of sliplining is compatible with the capacity requirements of the renovated pipeline.

Another important characteristic of PE piping is that pipes can be fused together or extruded to form extremely long sections before being used to slipline existing pipelines.

9.2 Applications

As previously described, sliplining is used to renovate many pipeline types. The following table provides an overview of sliplining applications and possible limitations.

Pipeline type	Suitable	Comments
Sewers	✓	(see note A)
Gas pipelines	-	
Potable water pipelines	✓	(see note B)
Chemical/industrial pipelines	✓	(see note C)
Straight pipelines	✓✓	
Pipelines with bends	✓✓	(see note D)
Circular pipes	✓✓	
Non-circular pipes	✓✓	(see note E)
Pipelines with varying cross-section	✓	(see note F)
Pipelines with lateral connections	✓	(see note G)
Pipelines with deformation	✓✓	(see note H)
Pressure pipelines	✓✓	

- (A) Sliplining can be used to renovate sewer lines, but is usually not the best method for gravity sewers because of the reduction in pipe diameter.
- (B) Approval from the relevant authorities is required for all materials that come into contact with potable water.
- (C) The pipe material must be resistant to chemicals, extreme temperatures, etc.
- (D) Normally, bends cannot be negotiated by the system.
- (E) PE pipes can be used for lining non-circular pipes (sewer lines), but hydraulic conditions must be taken into account because the floor of the new pipeline becomes raised.
- (F) The liner must fit the smallest diameter in the existing pipeline unless adapters are built into the line.
- (G) For sewers, it is necessary to excavate lateral connections and disconnect them before inserting the new pipe and in particular before injecting grout. Connection from inside the pipe is a possibility, although the process is more complicated than for close-fit renovation methods. For potable water lines, it is always necessary to excavate service line connections.
- (H) The method is not directly suitable for pipelines with considerable deformations.

Environmental conditions at the workplace

It is the responsibility of individual contractors to comply with current legislation on the work environment. The authorities are especially vigilant regarding possible work environment problems relating to the renovation of sewer systems.

Examples of the aspects that must be covered are:

- Workplace evaluations
- Safety organisation
- Health and safety plans
- Safety measures
- Safety equipment
- Welfare measures
- Personal hygiene
- Emergency plans

It should also be borne in mind that in addition to national legislation, local authorities can lay down rules and regulations for many aspects of the work environment.

Environmental aspects of sliplining products Product specifications should be used to ensure that the chosen product is suitable for the renovation in question. For example, greater demands are made on potable water pipelines than on sewer lines. In this case, it is important to ensure that all product information and approvals required by the authorities are available.

9.3 Preliminary surveying

To achieve the best possible result of pipeline renovation using sliplining techniques, it is important to carry out detailed preliminary surveying to determine, at the very least, the following:

- The condition of the existing pipeline – using closed circuit television (CCTV) inspection
- The need for cleaning – using CCTV inspection
- The location of any valves – especially when renovating pressure pipelines
- Pipeline length and depth
- Pipeline dimensions, deformities and displaced joints
- Water table depth
- Location of laterals
- Traffic load
- Lateral data – including dimensions, unused service lines, used service lines, and intruding service line connections
- Manhole condition

9.4 Preparatory work

Once necessary preliminary surveying has been completed and renovation is about to commence, there are several routines for the way in which preparatory work should be carried out in order to achieve effective pipeline renovation.

These include:

- Any planned over-pumping, its duration and the number of consumers affected
- Planned traffic diversions and their advertising
- Pipeline shut-off (timing, duration and number of laterals affected)
- Location and size of pits
- Investigation of the dimensions throughout the existing pipeline – the smallest diameter determines the diameter of PE pipe that can be used. For water pipelines, pipe dimension is given in advance, but it may be necessary to scrape off internal deposits
- Investigation of bends in the existing pipe-line

Usually, the preparatory work required depends on what the pipeline is designed to carry, and whether it is a sewer or pressure line. For a sewer, for example, preparatory work would include:

- Inspection and possible grinding of intruding service line connections, pipe sections and displaced joints on the existing pipeline
- Inspection and possible grinding or cutting away of scattered deposits
- Water jetting/root cutting
- Closing/blocking off unused service lines
- Restoration of the existing pipeline or parts of it when badly deformed

Design criteria and fusion welding

Sliplining projects are planned using current principles for calculating design criteria. Several sources of information on the subject are listed in the bibliography, but attention is particularly drawn to the following publications, both of which are published by the Pipe Centre, Danish Technological Institute:

Renovating Sewer Lines – Guidelines for Choice of Method, Design and Implementation (Renovering af afløbsledninger – retningslinier for valg, dimensionering og udførelse) (see references).

Renovating Potable Water Pipelines – Guidelines for Choice of Method, Design and Implementation (Renovering af vandledninger –

retningslinier for valg, dimensionering og udførelse) (see references).

Sliplining with PE pipes is mostly used for renovating pressure pipelines, especially when the pressure in the pipeline determines the choice of pipe pressure stage. The PE pipe should therefore be designed in accordance with the same principles as those applied to new pipes. Thin-walled liners can sometimes be used, assuming the existing pipe can provide the necessary structural support and that complete grouting of the annular space can be achieved with no part of the liner remaining unsupported. This is often difficult to check, and thin-walled liners are therefore not usually preferred for sliplining pressure pipelines.

Where gravity pipelines are concerned, external loads can be decisive for determining design criteria. Here, thick-walled PE piping may be chosen. If so, grout is sometimes injected, but merely to hold the PE pipe in position, thus making grout strength less important.

Another possibility is to fill the annular space with grout to form a structural element in the overall construction. In this case, the annular space must be completely filled with grout. It should, however, be pointed out that inspection of whether this has been achieved or not is difficult. In any event, the PE pipe must be designed so that it can resist both the internal and external loads it is subjected to during service and the loads it is subjected to during installation, not least pulling force and grouting pressure.

Over and above the internal and external loads that the pipe is subjected to during service, design

criteria calculations for PE pipes must take into account necessary pulling forces and maximum permissible bending during installation.

Finally, it is necessary to plan how the sliplining will be fastened or anchored in position. Changes in the temperature of the PE material or changes in pipeline pressure can cause considerable lengthways expansion or contraction of the piping. Anchoring must therefore ensure that the connections between the PE piping and the adjoining pipeline system are not damaged or spring leaks because of such changes in pipe length.

9.5 Installation

Sliplining with PE pipes

During the sliplining process, the PE pipe is pulled or pushed into the host pipe between a launch pit and a reception pit.

PE pipes can be fused together either above-ground or in the launch pit.

Fusion above ground may require long launch pits because of the limitations on bending set by the minimum permissible radius of curvature for PE pipes. This is especially true for deeply buried pipes and large diameter pipes.

Fusion in the launch pit allows the pit to be shorter, but the rate of installation is limited by the time taken to fuse pipe segments and cool welds. The cooling phase in particular is important for the service life of the finished pipeline because too short cooling times weaken the strength of the pipeline, in particular during installation, but also in the long term.

Sliplining work site.





Preparing to pull in a 500 mm diameter PE slipliner.

Beads are formed internally and externally on the PE pipe during fusion welding. In the case of sewer pipelines, both internal and external beads are often removed before pipe insertion. In the case of water pipelines, internal beads are not usually removed, in order to avoid the risk of pollution from the use of debanding tools.

Sammensvejsning af PE-rør

As previously mentioned, PE pipes can be either pushed or pulled into the existing pipeline. When pipes are pulled into position, the towing head is a very important component. It grips the new pipe and transfers the pulling force from the winch cable.

The towing head should provide a secure connection without producing high levels of localised tensile stress. In some systems, the end of the pipe is closed off to prevent soil or other debris from entering the pipe. This is especially important in the case of potable water pipelines.

A breakaway connector can be fitted between the winch cable and towing head to avoid subjecting the PE pipe to stress. Such connectors can be adjusted to separate at loads lower than the permissible load on the pipe. Although undesirable, a broken connector is usually preferable to the pipe being damaged with subsequent service failure. The use of breakaway connectors also induces operators to avoid using excessive pulling force during pipe insertion.

Small diameter PE pipes are often pulled into position with the aid of a sleeve made of diamond-shaped mesh. The sleeve is fastened to the

winch cable and pulled over the end of the PE pipe. During insertion, the sleeve tightens and grips the PE pipe which can then be pulled into position in the host pipe.

Short sections of small PE piping can be pulled into place manually, but most pipes must be pulled into place by a winch cable. The winch must provide a steady, progressive pull without snatching or uncontrollably varying the force. The winch must be carefully positioned and the cable carefully guided, and it is often necessary to place additional pulleys in the manhole or reception pit to ensure that the cable has an unobstructed path and does not rub against any part of the launch pit.

Numerous types of manually or hydraulically powered machines are available for pushing new pipes into existing ones. Some are designed to operate from the launch pit, while others are positioned on the ground immediately behind the pit. The machine grips the new PE pipe and pushes it forwards into the host pipe. The grip mechanism is then released and returned to the starting position, from which the process is repeated.

Connecting laterals and branch lines

Excavation is normally necessary to connect laterals and branch lines when sliplining gravity sewers.

Openings can be cut in the PE pipe before injecting grout so that an inflatable bag can be inserted into laterals and branch lines to seal them off and thus prevent grout from being forced into them. However, the complexity of such opera-

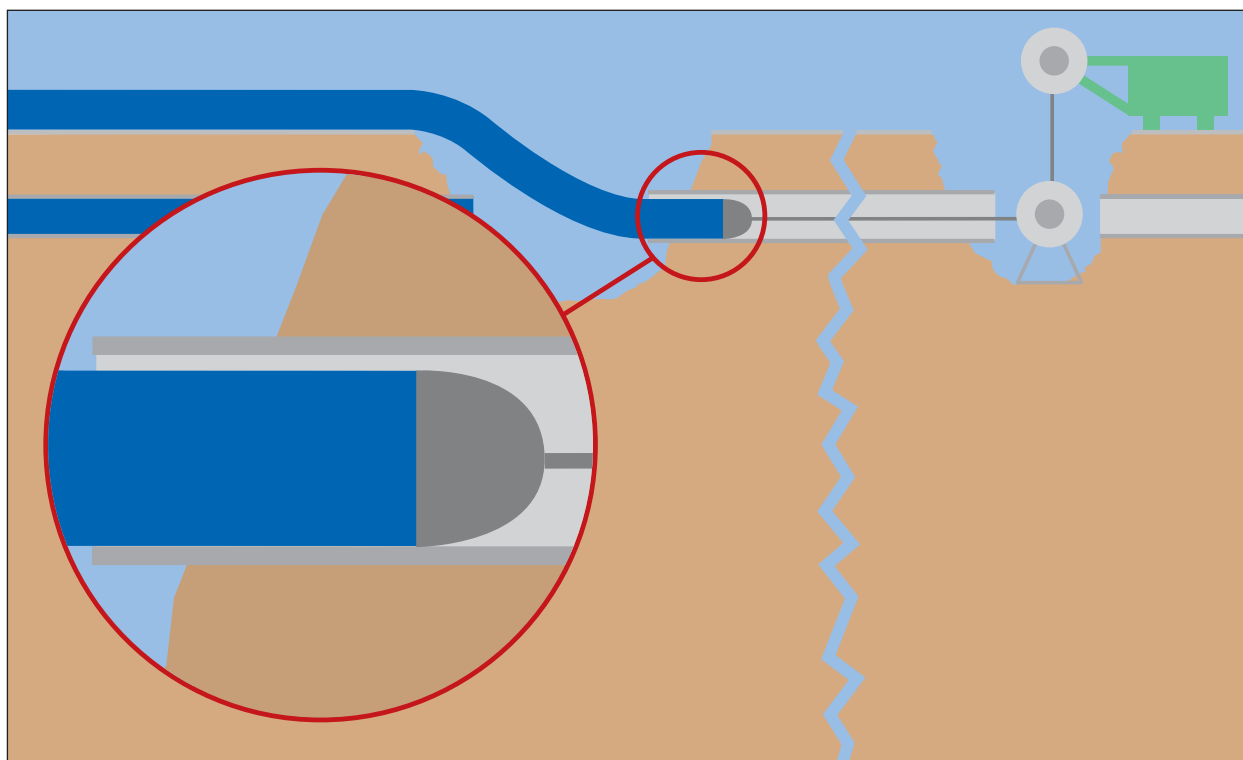

Pulling a PE pipe into position with a winch.

tions only justifies their use in situations where outside access via excavation is difficult or impossible. Moreover it is only possible to use the procedure in large diameter pipes.

Connections must be excavated and branch lines disconnected before grout is injected. Connecting laterals to PE liners is carried out in the same way as for new installations. Special connectors must be used to connect the new junction to the existing branch.

Where water lines are concerned, excavation is always necessary for connecting service lines or for making any other type of connection to the existing pipe.

Grouting

Lining systems in which the liner bonds to the host pipe to form a composite pipeline, and systems in which the new pipe only functions as a permanent mould for the annular grout require the use of cementitious grout with a compressive strength of 10-20 kPa.

Liners which are held in place by the host pipe, but do not need to bond to it, only require a grouting material capable of transferring loads from the one pipe to the other. The strength of some of the injection grouts used for this purpose corresponds to that of stiff clay – about 1 kPa.

Injection grout made of ordinary Portland cement and pulverised fly ash (OPC/PFA) is commonly used although numerous special grouting materials are available. One of these is a grout with extremely low viscosity which is capable of flowing through the annular space with the aid of gravity or minimum pressure and which sets within 20 minutes. One benefit of these grouts is that they allow stage grouting to proceed more rapidly than with conventional materials.

The forces that liners are subjected to during grout injection are often greater than those experienced during normal service. Failures due to grout pressure and flotation forces must be avoided. Flotation forces are often underestimated, especially for larger linings, and it should be kept in mind that the forces are related to the weight of grout displaced by the liner (i.e. the volume of the liner multiplied by the density of the grout) rather than the weight of grout in the annular space.

It is common practice to fill the liner with water during grouting as this helps counteract the flotation force and resist external pressure. Even so, since the density of most grouts is higher than 1.0, it may still be necessary to inject grout in stages. This is especially true for large gravity sewers,

where the gradient of the sewer is critical and flotation is unacceptable.

Renovating gas lines with sliplining

Several techniques have been developed for inserting a new PE pipe into an existing gas mains or service line without disconnecting the gas supply. In general, these methods rely on gas flowing through the annular space between the old and new pipelines during installation, and so entail a reduction in pipe bore. This may be acceptable in the case of old gas mains originally designed for gas with a lower calorific value or distributed at a lower pressure than is common today.

It is beyond the scope of this handbook to describe the many proprietary systems for live insertion. For obvious safety reasons, strict and detailed installation procedures have been laid down, and the following merely provides a general guide to basic principles. Systems are available for low and medium pressure mains.

The systems are not used in Scandinavia, but are still in use in the UK.

The first stage is to isolate the section of gas main to be renovated, while ensuring continued gas supply via a bypass at one or both ends of the isolated section. The new PE pipe is fed through gland seals attached to the existing mains in the launch pit and is pushed through the entire pipeline section to be renovated by pneumatic or hydraulic machinery. Typical insertion runs are 100–500 metres long.

There are many variations on the technique, but in the simplest version the new PE pipe is fed through gland seals to the reception pit where it can be connected to either the existing pipeline or to a new pipeline system designed for higher pressures. In all systems, the annular space between the old and the new pipe is used to maintain the supply of gas to consumers during installation. To facilitate the transfer of services to the new PE pipe, polyurethane foam is injected into the annular space to prevent the flow of gas, allowing the old pipe to be disconnected and the new connection made.

Gas mains with a diameter of 75–450 mm can be lined using the method described above.

Techniques are available for the renovation of gas service lines which allow the existing gas meter location to be maintained by inserting a PE pipe through a 90° elbow, a tee or through a number of long-radius bends. After the gas meter and main stopcock have been removed, a line-blowing assembly is connected to the service line

at the meter. Air is blown through the old pipe to remove any loose rust. The pipe receiver, bend and standpipe are fitted and air is blown quickly into the pipe to send a line to the far end. This line is used to pull a cable back through the pipe from a winch attached to the top of the pipe receiver. A short section of PE pipe is then pulled through the existing pipe to remove any remaining rust or encrustation. The full pipe section is installed with the aid of the winch and by pushing manually from the other end. Testing should be carried out after a brief pause to allow the pipe to recover from any stretching that occurred during installation. This sliplining technique can be adapted for renovating water pipelines.

An insertion method has been developed for sliplining gas service lines in which a new PE pipe is pushed into an existing steel pipe via a gland sealing system attached to the old pipe either inside the consumer's premises or in a small excavation outside the building. Excavation is not necessary where the service line is connected to the mains. The annular space between the old and new pipes is filled with a permanent sealing compound which is prevented from entering the pipeline by a pointed nose-cone attached to the leading end of the PE pipe. The system is suitable for steel pipes with a diameter of 20–50 mm operating at pressures of up to 50 mbar. The method is currently being adapted and developed to facilitate its use at higher pressures and in water pipeline systems.

Spiral-wound sliplining

Methods have been developed for forming pipes or liners in situ by spirally winding a PVC strip. These methods reduce or eliminate the need to excavate a launch pit. To increase its stiffness, the strip is reinforced with T-profiles on what will become the outer face. In some systems, the edges of the strip lock together to form a water-tight seal, while in other systems, a separate sealing strip is used to join adjacent turns of the helix. The liner – known as a spirally wound liner – is formed by a hydraulically driven winding machine which is usually located down a man-hole or in a small, excavated launch pit. The liner is gradually pulled through the host pipe as further turns of the helix are added. Since the entire liner rotates during installation, the system is usually limited by friction and the weight of liner the machine is capable of winding. Flotation can be used to reduce the load.

An alternative spiral winding technique uses a winding machine that travels through the host pipe as it forms the liner, thus eliminating the need to rotate the liner itself. Non-circular pipe-line sections, including oval, egg-shaped and rectangular pipes, can be lined with the aid of a winding cage shaped to suit the host pipe. For larger pipes, steel reinforcement can be inserted between the ribs to increase liner ring stiffness.

After the liner has been installed, grout is injected into the annular space in the same way as for sliplining with other pipe materials. The external ribs provide a mechanical key between liner and grout.

9.6 Completion work

After installation, it is often necessary to carry out completion work. This may, for example, take the form of:

- Leak testing
- Consumer information following service line reinstatement
- Manhole finishing to ensure continued smooth flow
- Service line reinstatement so that wastewater from individual consumers can again be lead to the main sewer
- Final CCTV inspection to document the completed renovation

The purpose of completion work is to ensure that tasks over and above actual pipeline renovation are performed and documented in accordance with the contractor's own quality requirements and to the satisfaction of the pipeline owner.

9.7 Quality assurance and documentation

A final review compares the documented work performed with the requirements and descriptions of the contractor and any supervising authorities. A final review should always be conducted, its purpose being to confirm that work done is in compliance with agreements made.

When a renovation project is completed, the contractor provides the pipeline owner with documentation of the quality of the work performed in the form of a quality manual. In this respect, it is important that during the tendering phase the pipeline owner ensures that such documentation can be prepared and submitted on completion of the renovation work. The quality manual should at least contain or state the following:

- Declaration stating which products/installation methods have been used
- How preparatory work and preliminary surveying have been performed
- Materials handling
- Availability and use of installation manuals
- How supplementary work and final quality assurance have been carried out and documented
- The form of final documentation
- How deviations in relation to the instruction manual have been dealt with
- Complaint processing

SLIPLINING

9

METHODS

8

10.1 Introduction

NO-DIG rehabilitation using close-fit lining has been used extensively in Scandinavia for the last 30 years.

The technique has proved successful for sewer systems, potable water and gas supply lines, and last, but not least, industrial process pipelines. In Scandinavia, pipelines up to 1200 mm in diameter have been renovated using close-fit linings.

After a long period without new products being introduced, it is apparent that close-fit lining is currently developing into an interesting NO-DIG alternative with several new systems appearing on the market over recent years.

What is close-fit lining?

Internationally the method is known as close-fit lining, while it is known in Scandinavia as "close-fit foring" or "stram foring".

Close-fit lining is usually performed in one of two ways in Scandinavia.

In the first, plastic liners are folded in the factory during production and then wound onto large reels. Following delivery to the renovation site, the liner is heated until it becomes flexible, allowing it to be pulled through the host pipe from "manhole-to-manhole". Once in place, the liner is forced against the inside surface of the host pipe using heat and pressure to form a new close-fit pipeline. Lateral connections are re-opened using a remote-controlled robotic cutter or by conventional excavation methods.

The other well-known close-fit lining method is swage lining, a technique that involves the use of long, fused sections of PE piping. Launch and reception pits must be dug first. The diameter of the PE pipe is then reduced, e.g. mechanically, just before the liner is inserted into the existing pipe. After being pulled into position, the liner expands to its original size and thus fits snugly into the host pipe.

10.2 Applications

It is important to choose the best renovation method for each individual project. The space available, the chemical composition of the fluid carried by the pipeline, the pressure and temperature in the pipeline, the number of laterals, the number of manholes, etc. must be assessed from project to project.

As previously mentioned, close-fit lining is used to renovate many pipeline types. The following table provides an overview of close-fit applications and possible limitations.

Pipeline type	Suitable	Comments
Sewers		(see note A)
Gas pipelines	✓	
Potable water pipelines	✓	(see note B)
Chemical/industrial pipelines	✓	(see note C)
Straight pipelines	✓	
Pipelines with bends		(see note D)
Circular pipes	✓	
Non-circular pipes		(see note E)
Pipelines with varying cross-section		(see note F)
Pipelines with lateral connections		(see note G)
Pipelines with deformation		(see note H)
Pressure pipelines	✓	

- (A) Close-fit lining can be used to renovate sewers from manhole to manhole, but is not usually the preferred method for gravity sewers as pipe diameter is reduced.
- (B) Approval from the relevant authorities is required for all materials that come into contact with potable water. Both fold-and-form lining with plastic pipes and swage lining with fuse-jointed PE pipes are suitable for renovating potable water pipelines. Both methods require the excavation of launch and reception pits on the run to be renovated. In addition, valves, service line connections and sharp bends must be dug free before renovation work is begun.
- (C) Each specific project must be assessed to find the most suitable renovation method. The available space, the chemical composition of the fluid carried by the pipeline, the pressure and temperature in the pipeline, the number of service lines, the number of manholes, etc. must be assessed from project to project.
- (D) Bends cannot normally be negotiated with close-fit lining methods.
- (E) PE liners can be used for non-circular pipes (sewer lines), but hydraulic characteristics must be taken into account because the floor of the new pipeline becomes raised.

- (F) The liner must fit the smallest diameter in the existing pipeline unless adapters are built into the line.
- (G) For sewers, it is not necessary to excavate lateral connections, as they can be re-opened from inside the pipe using robotic cutters. It is always necessary to excavate service line connections on potable water pipelines.
- (H) The method is not directly suitable for pipelines with considerable deformation.

Environmental conditions at the workplace

It is the responsibility of individual contractors to comply with current legislation on the work environment. The authorities are especially vigilant regarding possible work environment problems relating to the renovation of sewer systems.

Examples of the aspects that must be covered are:

- Workplace evaluations
- Safety organisation
- Health and safety plans
- Safety measures
- Safety equipment
- Welfare measures
- Personal hygiene
- Emergency plans

It should also be borne in mind that in addition to national legislation, local authorities can lay down rules and regulations for many aspects of the work environment.

Sorting PE pipes allows reuse.



Environmental aspects of close-fit products

Product specifications should be used to ensure that the chosen product is suitable for the renovation in question. For example, greater demands are made on potable water pipelines than on sewer lines. In this case, it is important to ensure that all product information and approvals required by the authorities are available.

Any surplus liner must be satisfactorily disposed of in a safe way. Information on how the material used can be disposed of or re-cycled can be obtained from the contractor or manufacturer. Well-known products like PE, PVC and modified PVC that are currently used to manufacture close-fit liners can be delivered to approved waste collection points or returned to the manufacturer for re-cycling.

10.3 Preliminary surveying

To achieve the best possible result of pipeline renovation using close-fit lining techniques, it is important to carry out detailed preliminary surveying to determine, at the very least, the following:

- The condition of the existing pipeline – using closed circuit television (CCTV) inspection
- The need for cleaning – based on CCTV inspection
- Valve locations (especially important when swage-lining pressure lines)
- Pipeline length and depth
- Pipeline dimensions, deformities and displaced joints
- Water table depth
- Location of laterals
- Traffic load
- Lateral data, including dimensions, unused service lines, used service lines and intruding service line connections
- Manhole condition
- Location and size of pits

10.4 Preparatory work

Once necessary preliminary surveying has been completed and renovation is about to commence, there are several routines for the way in which preparatory work should be carried out in order to achieve effective pipeline renovation.

These include:

- Any planned over-pumping, its duration and the number of consumers affected
- Planned traffic diversions and their advertising
- Pipeline shutoff (timing, duration, number of laterals affected)
- Location and size of pits
- Inspection of bends in the existing pipeline

Usually, the preparatory work required will depend on what the pipeline is designed to carry, and whether it is a sewer or pressure line. For a sewer, for example, preparatory work would include:

- Inspection and possible grinding of intruding service line connections, pipe sections and displaced joints on the existing pipeline
- Inspection and possible grinding or cutting away of scattered deposits
- Water jetting / root cutting
- Closing/blocking off unused service lines
- Restoration of the existing pipeline or parts of it when badly deformed
- Prevention of ground water infiltration (temporary sealing to allow renovation)
- General grinding and cleaning of internal corrosion throughout the pipeline

Design criteria and fuse-jointing

Close-fit projects should be planned using the current principles for design criteria calculation described in the following publications, both of which are published by the Pipe Centre, Danish Technological Institute:

- Renovating Sewer Lines – Guidelines for Choice of Method, Design and Implementation (Renovering af afløbsledninger – retningslinier for valg, dimensionering og udførelse) (see references)
- Renovating Potable Water Pipelines – Guidelines for Choice of Method, Design and Implementation (Renovering af vandledninger – retningslinier for valg, dimensionering og udførelse) (see references)

10.5 Installation

At the heart of any renovation project using close-fit lining is, of course, the installation of the liner itself. It is therefore important for both the pipeline owner and the contractor to ensure that both the production of the liner and its installation are carried out under controlled conditions that can subsequently be documented in writing.

As swage lining is usually used for potable water and gas supply lines, it is necessary to excavate valves, service line connections and sharp bends before installing the liner. Folded plastic liners for potable water pipelines are installed in more or less the same way as swage lining, while folded liners for sewers can usually be installed from "manhole-to-manhole".

In the following, the installation of a folded liner and its subsequent expansion by heating is described. It is assumed that the above-mentioned preliminary surveying and preparatory work have been carried out.

Close-fit lining and subsequent lateral installation.





PE pipes are fusion-joined prior to installation.

Liner insertion

After heating, the reel holding the folded liner is positioned beside the manhole from which the liner is to be installed. Beforehand, a winch cable is pulled through the pipeline to be renovated. It is important to ensure that the liner has the correct insertion temperature, i.e. the temperature at which the liner is most flexible. After fitting the towing head and cable, it must be ensured that the liner is not subjected to excessive bending during insertion. The liner must also be protected from damage caused by it rubbing against the sides of the manhole or the launch and reception points. The force used during insertion must never exceed the permissible pulling force for the liner in question.

Liner heating

After insertion, a hot air tool is fitted over the end of the liner in the manhole. The hot air tool is an end cap through which the liner can be heated by steam.

The liner is then heated to the temperature recommended by the manufacturer. The temperature used will depend on the product, its dimensions and the ambient temperature. When the re-

commended temperature has been reached, the liner is pressurised in accordance with manufacturer recommendations. This pressure is usually between 0.6 and 3.0 bar depending on the material composition of the liner in question. On being subjected to pressure, the liner expands, thus forming a close-fit with the host pipe. The liner must then cool while still under pressure (e.g. using compressed air from a compressor) to ensure that it remains tightly pressed against the host pipe. After cooling, the hot air tool can be removed and necessary completion work performed.

10.6 Completion work

After installation, it is often necessary to carry out completion work. This may, for example, take the form of the following:

- Leak testing
- Consumer information following service line reinstatement
- Manhole finishing to ensure continued smooth flow
- Service line reinstatement so that wastewater from individual consumers can again be lead to the main sewer

- Final CCTV inspection to document the completed renovation

The purpose of completion work is to ensure that tasks over and above actual pipeline renovation are performed and documented in accordance with the contractor's own quality system and to the satisfaction of the pipeline owner.

10.7 Quality assurance and documentation

A final quality review compares the documented work performed with the requirements and descriptions of the contractor and any supervising authority. A final review should always be conducted, its purpose being to confirm that work done is in compliance with agreements made.

When a renovation project is completed, the contractor provides the pipeline owner with documentation of the quality of the work performed in the form of a quality manual. In this respect, it is important that during the tendering phase the pipeline owner ensures that such documentation can be prepared and submitted on completion of the renovation work. The quality manual should at least contain or state the following:

- Declaration stating which products/installation methods have been used
- How preparatory work and preliminary surveying have been performed
- Materials handling
- Availability and use of installation manuals
- How supplementary work and final quality assurance have been carried out and documented
- The form of final documentation
- How deviations in relation to the instruction manual have been dealt with
- Complaint processing
- Effect of materials on the environment

CLOSE-FIT LINING



10

METHODS



6

11.1 Introduction

Renovating sewer lines with trenchless techniques has undergone explosive development in the Western World since the early 1980s – both with respect to the extent of their use and the methods employed.

Most of the sewer network consists of pipes with small cross-sectional diameters. This explains why the renovation of small-bore pipes has drawn most attention, both in terms of commercial exploitation and technological research and development. In particular, lining with cured-in-place pipes (CIPP) has been used extensively to renovate small diameter pipelines.

In this section, the term "large diameter pipeline" will be used more as a concept than as a definition, and the techniques described are relevant to pipelines with diameters larger than approximately 1200 mm.

Such lines constitute only a fraction of the entire pipeline system, and they are found only in larger towns and cities or as transport lines between individual towns and cities. The damage found in these pipelines is generally the same as that found in small-bore lines: cracks and fractures or the corrosion of concrete or masonry often as a result of aggressive wastewater. Many of the pipes are old and have now reached an age where renovation is necessary to avoid future collapse.

Large diameter pipelines are often located at great depth in the centre of towns and cities. Excavation can therefore be an insurmountable project, both with regard to time and money, and because of the enormous impact such work has on local residents, businesses and traffic.

What are panels?

Many systems for lining large diameter pipelines are currently available. This section will, however, only deal with fibreglass liners, manufactured either as complete pipes or as pipe segments, i.e. panels. Fibreglass liners are available in numerous types and makes. In some systems, only circular liners are available, while in others, egg-shaped liners can also be supplied. In a few systems, liners can be manufactured for more or less any existing pipeline profile.

11.2 Applications

It is important to choose the best renovation method for each individual project. The available space, the chemical composition of the fluid carried by the pipeline, the pressure and temperature

in the pipeline, the number of laterals, the number of manholes, etc. must be assessed from project to project.

Pipeline type	Suitable	Comments
Sewers	✓	(see note A)
Gas pipelines	-	
Potable water pipelines	-	
Chemical/industrial pipelines	✓	(see note B)
Straight pipelines	✓✓	
Pipelines with bends	✓✓	
Circular pipes	✓✓	
Non-circular pipes	✓✓	
Pipelines with varying cross-section	✓	
Pipelines with lateral connections	✓✓	
Pipelines with deformation	✓✓	
Pressure pipelines	-	

The above table provides an overview of applications and possible limitations.

- (A) The method is suitable for manhole-to-manhole renovation of sewer lines with diameters larger than 1200 mm.
- (B) Each project must be individually assessed to find the most suitable renovation method. The available space, the chemical composition of the fluid carried by the pipeline, the pressure and temperature in the pipeline, the number of laterals, the number of manholes, etc. must be assessed from project to project.

Profiles and materials

Numerous profiles and standards are used throughout the world. Most existing large diameter pipelines were built in situ of concrete or bricks. In many countries, the construction of sewers and associated structures was an independent trade, and an impressive quality of workmanship and materials is often found in pipelines that are 75–100 years old.

Circular and egg-shaped profiles are common, but rectangular pipelines, sometimes with arched tops or so-called eye-shaped profiles, are also found. As these pipelines are often concrete-cast or brick-built in situ, renovation systems must be able to cope with varying dimensions.

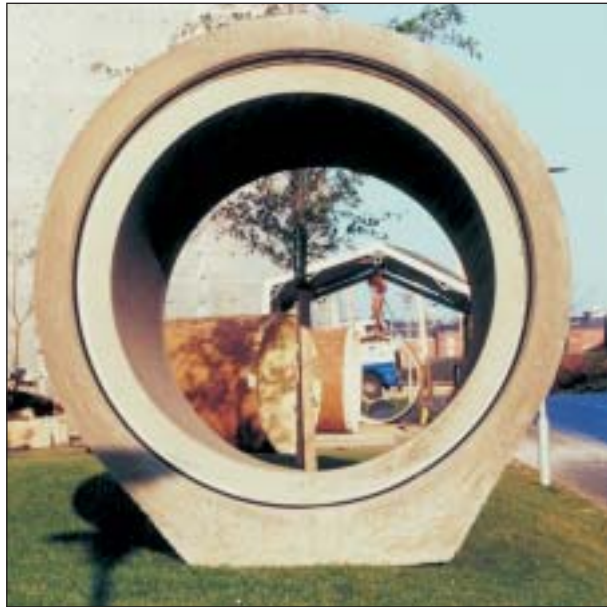

Large profiles.

Fibreglass panels

Existing pipelines are usually lined with prefabricated, fibreglass liners by personnel working in the pipeline itself who position each pipe segment manually. However, in some cases, short-pipe sliplining is possible from manholes or pits.

Relatively short lengths of liner are normally used as they must be manoeuvred by hand and inserted manually into the pipeline through existing manholes and access chambers or via launch pits of limited size. Typically, segments are 1-2 m long.

Most liners are machine-made as centrifugal-cast or spun pipes. Such liners are only available as complete pipes. A few liners are made by hand in moulds, thus allowing liners to be manufactured in segments. "Channeline" is an example of this type of system. Liners have tongue and groove joints that are sealed with either rubber sealing rings or polyurethane or epoxy filler. Liner segments

have specially developed longitudinal joints that are sealed with epoxy filler.

Whether whole pipes or liner segments are used in specific renovation projects depends on several factors, including the following:

- Pipeline access may be limited to existing manholes where there is only room for inserting pipe segments. In such circumstances, segments must be connected as installation progresses in the host pipe
- Pipe transport from the factory to the renovation site can be expensive and problematic where large diameter pipelines are concerned. These can therefore be delivered in segments and subsequently assembled either in the pipeline itself or – if access conditions to the pipeline allow it – above ground
- Segments can be used if the size and weight of the entire pipe make it difficult to handle
- Bends or other obstacles in the pipeline can make it necessary to install the liner in segments

Pipe material

The pipes are made of various combinations of fibreglass mats, glass fibres, polyester, vinyl ester, epoxy resin and, sometimes, silica sand.

When the pipes are machine-made, a 2–3 mm thick fibreglass mat is laid first and then impregnated with polyester to form a corrosion-resistant layer. Subsequently, the mould is rotated while polyester-soaked fibres are spun on. Fine silica sand is sometimes applied at the same time as the fibres. The spinning process is continued until the required wall thickness is achieved.

"Channeline" is hand-made in moulds and can therefore be produced either as complete pipes or as pipe segments. This system also allows the production of asymmetrical profiles or profiles that have negative curvature for part of the profile – as in the case of profiles with floor channels for example.

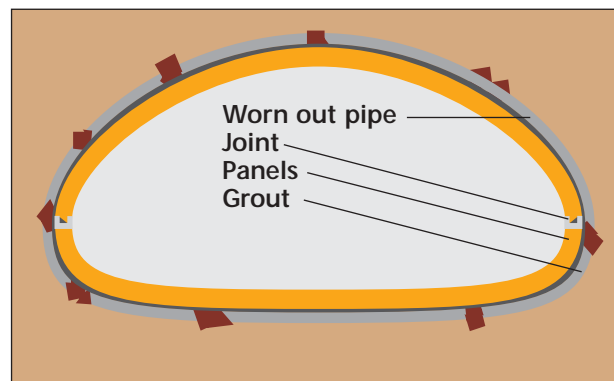
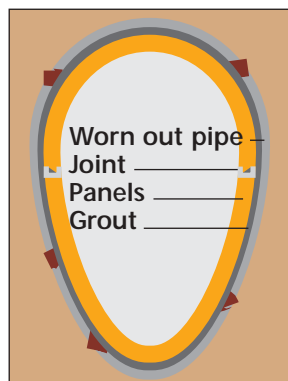
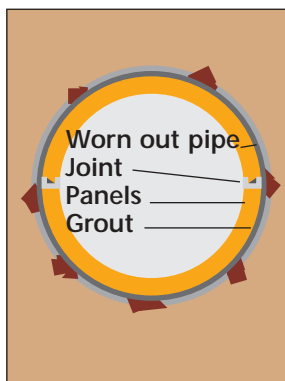



The pipes must be able to be installed via existing manholes and other constructions.

As in other liner systems, the type of resin and fibreglass used is chosen on the basis of requirements for strength and resistance to chemicals and extreme temperatures.

Environmental conditions at the workplace

It is the responsibility of individual contractors to comply with current legislation on the work environment. The authorities are especially vigilant regarding possible work environment problems relating to the renovation of sewer systems.

Examples of the aspects that must be covered are:

- Workplace evaluations
- Safety organisation
- Health and safety plans
- Safety measures
- Safety equipment
- Welfare measures
- Personal hygiene
- Emergency plans

It should also be borne in mind that in addition to national legislation, local authorities can lay down rules and regulations for many aspects of the work environment.

11.3 Preliminary surveying

To achieve the best possible result of pipeline renovation using panels, it is important to carry out detailed preliminary surveying to determine, at the very least, the following:

- The condition of the existing pipeline – using closed circuit television (CCTV) inspection
- The need for cleaning – based on CCTV inspection
- Pipeline length and depth
- Pipeline dimensions, deformities and displaced joints
- Water table depth
- Location of laterals
- Traffic load
- Service line data, including dimensions, unused service lines, used service lines and intruding service line connections
- Manhole condition
- Location and size of pits

11.4 Preparatory work

Once necessary preliminary surveying has been completed and renovation is about to commence, there are several routines for the way in which preparatory work should be carried out in order to achieve effective pipeline renovation.

These include:

- Any planned over-pumping, including its duration and the number of consumers affected.
- Water quantities of up to 500-2000 litres per second can be necessary
- Planned traffic diversions and their advertising
- Pipeline shut-off (timing, duration, number of laterals affected)
- Grinding of intruding service line connections

- Measurement of internal diameter
- Grinding or cutting away of scattered deposits
- Water jetting/root cutting if necessary
- Closing/blocking off unused service lines
- Restoration of the existing pipeline or parts of it (e.g. repair of cracks and fractures)
- Sealing leaks to prevent ground water infiltration (temporary repair to allow renovation)

Renovating large diameter pipelines requires detailed planning and close collaboration between the pipeline owner, contractor and consultant.

In the case of storm sewers, the method has the advantage that over-pumping is not always necessary. If it should rain while work is being carried out, the pipe can simply be abandoned, and work recommenced when the rain stops. Work in progress is not damaged by flooding.

Panel design criteria

Liners can be designed and constructed as self-supporting, flexible pipes. Alternatively, strength can be achieved by sandwiching together the host pipe, the liner and the concrete filling the annular space between the two.

Different design criteria are used in different parts of the world. Where there are no national standards, guidelines from the Water Research Centre in the UK are often used. A manual on pipeline renovation has been published by the Water Research Centre in which design criteria for sandwich constructions (type I) and for flexible pipes (type II) are described. It is outside the scope of this handbook to describe design criteria in detail.

In addition to static calculations, the hydraulic capacity of the pipeline should be investigated and calculated. It should be mentioned that despite renovation inevitably reducing pipe diameter, the resulting smooth surface will usually increase hydraulic capacity in relation to the existing pipeline.



Panels ready for installation.

11.5 Installation

Runs of up to 200-300 meters can be installed from a manhole or launch pit. However, ventilation and escape routes must be provided at shorter intervals.

A small work site should be established at ground level. This should be cordoned off to ensure the safety of workers and passers-by. There should be room for necessary installation equipment and for lorries to deliver material and equipment. A crane should be positioned above the launch pit to lower panels to the pipeline entrance. There should also be a compressor, a generator as well as tool storage and personnel facilities.

The panels are dragged or transported to their position in the pipeline. Work is started at the opposite end of the pipeline so as to finish in the launch pit. Packing pieces are wedged between the liner and the host pipe as installation progresses. If there is room, structural irregularities can



Mobile crane for lowering panels into a manhole.

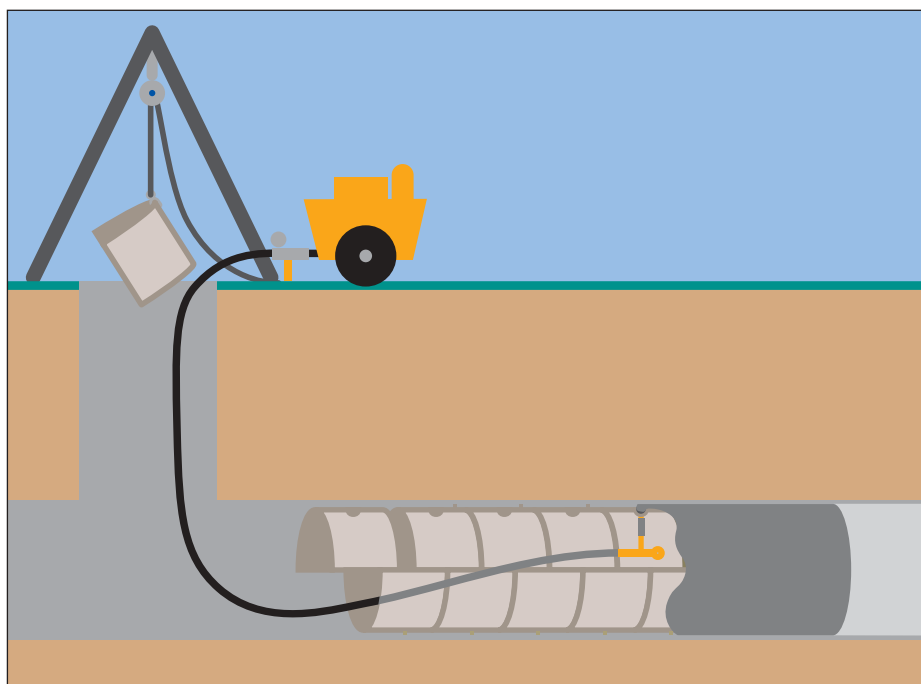

Schematic illustration of pipeline renovation using panels. The panels are wedged into place and the annular space is subsequently filled with concrete.

be evened out to a certain extent if the dimensions of the panels and existing pipe are large enough to allow adjustment in the positioning of individual panels.

Once panels have been positioned throughout the length of the pipeline, the annular space is filled with concrete. Pumpable concrete should be used. Care must be taken during the pumping process to prevent the panels from being subjected to excessive external pressure. This is done by checking the pump pressure and the flotation forces that the panels are subjected to by the fluid concrete. In this respect, it should be noted that concrete creates greater flotation than water because of its higher density. Flotation forces can be restricted by using foamed concrete which has lower density. The possibility of using foamed concrete is, however, limited if the concrete is to contribute to pipe strength, i.e. foaming reduces the compressive strength of the concrete. Another possibility for reducing flotation forces is to inject the concrete in two or three stages while allowing it to set between successive injections.

Changes in pipe diameter can be negotiated with prefabricated transition panels. Such panels are often expensive because a mould must be made for each individual irregularity. Another possibility is to cut the panels to be installed on either side of the irregularity so that they fit and then connect the two with a matrix made by

hand on site. Bends are similarly negotiated using prefabricated segments or panels cut to fit.

As with cured-in-place linings, service line connections are covered over and reopened once the panels are in place. Watertight connections can be established with filler, fibreglass matrix or transition profiles – or a combination of these methods.

Depending on various factors, including the diameter and length of the pipeline, the weight of the panels and the number of connections, advance rates of 5-30 metres per day can be expected.

Safety measures

As the personnel installing the pipe work in the pipeline itself, several safety and work environment requirements must be met.

The pipeline section must be effectively closed off upstream (and possibly also downstream) to ensure that wastewater cannot enter. If this is accomplished with inflatable sealing plugs, the plugs must be securely held in place, with chains for example, and the pressure in them constantly monitored. Two plugs should be positioned upstream as an extra precaution. The pumps must be constantly monitored to ensure that the level of wastewater behind the barricade does not become so high that it subjects the plugs to excessive loads.



Fitting panels in an existing pipeline.

Adequate light must be supplied and mechanical ventilation must provide sufficient fresh air. A gas detector must be used continuously to monitor oxygen levels and to warn personnel of the presence of poisonous or explosive gases.

There must be escape routes from the pipeline in both directions and there must always be a watchman in the launch pit who is continuously in touch with personnel in the pipeline. There must be a telephone and emergency equipment on site, and personnel must be instructed in emergency procedures.

As is the case with all other sewer work, personnel must, of course, be vaccinated.

Fastening panels to the existing pipeline.



11.6 Completion work

After installation, it is often necessary to carry out completion work. This may, for example, take the form of the following:

- Consumer information following service line reinstatement
- Manhole finishing to ensure continued smooth flow
- Service line reinstatement so that wastewater from individual consumers can again be lead to the main sewer
- Final closed circuit television (CCTV) inspection and/or visual inspection to document the completed renovation
- Leak testing can be carried out, but many large diameter systems are difficult to seal effectively

The purpose of completion work is to ensure that tasks over and above actual pipeline renovation are performed and documented in accordance with the contractor's own quality system and to the satisfaction of the pipeline owner.

11.7 Quality assurance and documentation

When a renovation project is completed, the contractor provides the pipeline owner with documentation of the quality of the work performed. In this respect, it is important that during the tendering phase the pipeline owner ensures that such documentation can be prepared and submitted on completion of the renovation work. During the tendering phase, the pipeline owner or the consultant should ensure that the documentation contains or states the following:

- Declaration stating which products/installation methods have been used, including mould tolerances and use of correct materials (strength, chemical resistance)
- How preparatory work and preliminary surveying have been performed
- Materials handling, including documentation for correct lamination parameters (duration times, curing, the absence of air)
- Availability and use of installation manuals
- How supplementary work and final quality assurance have been carried out and documented, including documentation that the panels are not damaged and that they are correctly installed (connections, gradient, blocking up, injection)
- The form of final documentation
- How deviations in relation to the instruction manual have been dealt with
- Complaints processing
- Effect of materials on the environment

If the above has been implemented in a quality manual, the pipeline owner and consultant are already reasonably assured in the tendering phase that the renovation work performed can be documented in a responsible way.



Thorough preparation ensures a successful result.



Checking the installation work.

PANELS

11

METHODS

12.1 Introduction

This section describes pipe bursting techniques, their applications and benefits (both in general and in relation to other trenchless pipeline rehabilitation techniques), and how pipe bursting is carried out technically.

Pipe bursting can be used to rehabilitate sewer, water, gas and other pipelines, and is used particularly to up-size the capacity of existing pipelines or where existing pipelines are in such poor condition that renovation is impossible and replacement is therefore required. Pipe bursting is also used in situations where it is not possible to use open-cut techniques on the entire stretch of pipeline or where excavation is very inconvenient for local residents and/or traffic.

The technique was developed by British Gas who used some of the principles to renovate existing gas pipelines. Techniques for using soil displacement hammers/hydraulic bursters mounted behind the bursting head (see photo), and for using steel rods to form a protective sleeve around the new pipe during insertion into the existing pipe were developed later.

Since then, the use of protective rods has been abandoned, and PE pipes with a higher pressure rating and thicker walls are presently used.

The purpose of soil displacement hammers/pneumatic bursters is to displace the soil surrounding the existing pipeline, to realign the pipeline and to allow considerable up-sizing using relatively little pulling force.

More recently, a system has been developed that uses only static pulling force, i.e. pipe bursting without an impact mole. This method utilises relatively high pulling force without soil displacement. Both methods are currently in use.



Bursting head.

Impact mole (before the pipe and bursting head are fitted).



What is pipe bursting?

All currently available methods for pipeline renovation using pipe bursting techniques are based on the principle of a PE pipe being attached to an over-sized "bursting head" thus allowing a new pipe with a larger diameter than the existing pipe to be installed. The bursting head with the new pipe attached is pulled through the existing pipeline with the aid of a winch system. The new pipe therefore takes the same path as the existing pipeline.

The method of fracturing or bursting an existing pipe and subsequently inserting a new pipe along the same path has had many names over the years. In Danish, it has been known as "lang-rørsforing, foring med sammensvejste lange rør, rørsprængning, pipe cracking and pipe bursting".

In pipe bursting methods using pulling force, the existing pipe is split rather than crushed. The new pipe is pulled into position using substantial pulling force alone.

The "official" Danish term for pipe bursting is "rørsprængning" as this is the term used in the Danish Control Scheme for Pipeline Rehabilitation (Kontrolordning for ledningsrenovering) for this rehabilitation technique.

In the following, a distinction is made between pipe bursting with a pneumatic impact mole or and pipebursting without such a tool. The Danish term "rørsprængning uden raket" refers to pipebursting without an impact mole.

12.2 Applications

It is important to choose the best renovation method for each individual project. The available space, the chemical composition of the fluid carried by the pipeline, the pressure and temperature in the pipeline, the number of laterals, the number of manholes, etc. must be assessed from project to project.

As previously mentioned, pipe bursting is used for renovating a variety of pipeline types. The following table provides an overview of pipe bursting applications and possible limitations.

Pipeline type	Suitable	Comments
Sewers	✓	
Gas pipelines	✓	(see note A)
Potable water pipelines	✓	
Chemical/industrial pipelines	✓	
Straight pipelines	✓	
Pipelines with bends	✓	(see note B)
Circular pipes	✓	
Non-circular pipes	✓	(see note C)
Pipelines with varying cross-section	✓	(see note D)
Pipelines with lateral connections	✓	
Pipelines with deformation	✓	(see note E)
Pressure pipelines	✓	

- (A) Grooves in the pipe surface must be documented and ventilation must be assured to avoid gas pockets.
- (B) Depending on whether there are bends or shallow bends up to 20°.
- (C) Becomes circular after renovation.
- (D) The entire run can have the same dimension after renovation or the dimension can change along the run.
- (E) Deformities are removed during pipe bursting.

Pipe bursting renovation techniques allow the existing pipeline to be up-sized while at the same time removing displaced joints and realigning the pipeline. Moreover, the method does away with the need for much of the preparatory work – pipeline flushing, grinding of intruding lateral connections, root cutting, cutting of displaced joints, etc. – required by other renovation methods.

When pipe bursting is used below the water table or when the existing pipeline is surrounded by sand, the pneumatic impact mole can create a vacuum that prevents progress. As a rule, the prevailing soil conditions will have been investigated before work is commenced, thus preventing this situation from arising, either by locally lowering the water table or by using pipe bursting techniques based solely on high pulling forces and without the use of pneumatic moles.

Environmental conditions at the workplace

It is the responsibility of individual contractors to comply with current legislation on the work environment. The authorities are especially vigilant regarding possible work environment problems relating to the renovation of sewer systems.

Examples of the aspects that must be covered are:

- Workplace evaluations
- Safety organisation
- Health and safety plans
- Safety measures
- Safety equipment
- Welfare measures
- Personal hygiene
- Emergency plans

It should also be borne in mind that in addition to national legislation, local authorities can lay down rules and regulations for many aspects of the work environment.

Environmental aspects of the product

Polyethylene (PE) is one of the most environment friendly products used for renovating pipelines. PE is based on oil and contains no toxic additives.

12.3 Preliminary surveying

To achieve the best possible result of pipeline renovation using pipe bursting techniques, it is important to carry out detailed preliminary surveying to determine, at the very least, the following:

- The conditions of the existing pipeline – using closed circuit television (CCTV) inspection
- The need for cleaning – based on CCTV inspection
- Location of any valves
- Pipeline length and depth
- Pipeline dimensions, deformities and displaced joints and bends
- Water table depth
- Location of laterals
- Traffic load
- Lateral data, including dimensions, unused service lines, used service lines, intruding service line connections
- Manhole condition



Successful pipe bursting requires thorough preliminary surveying.

12.4 Preparatory work

Once necessary preliminary surveying has been completed and renovation is about to commence, there are several routines for the way in which preparatory work should be carried out in order to achieve effective pipeline renovation.

These include:

- Any planned over-pumping, its duration and the number of consumers affected
- Planned traffic diversions and their advertising
- Pipeline shut-off (timing, duration, number of laterals affected)
- Size and location of pits
- Registration and marking of lateral connections

Usually, the preparatory work required will depend on what the pipeline is designed to carry, and whether it is a sewer or pressure line. For a sewer, for example, preparatory work would include:

- Excavation of laterals and their disconnection from the main, e.g. by placing vertical supports in the excavations (see photo below)
- Breaking up manhole floors so that the bursting head and PE pipe can pass through without raising the pipeline profile
- Closing off/sealing unused laterals

Vertical supports positioned above lateral connections.





Fuse-joined PE pipe ready for installation.

Design criteria and fuse-joining

Design criteria for PE pipes are described in the Danish Control Scheme for Pipeline Rehabilitation.

Butt-fusion of the PE pipes must be carried out by qualified personnel in accordance with manufacturers' recommendations. Welding beads formed during butt-fusion are usually removed from inside the pipe.

12.5 Installation

In pipe bursting with long, fuse joined pipes, the new PE pipe is butt-fused to form a single long pipe (see photo above) and, depending on what the pipeline is to carry, the welding beads formed are removed from inside the pipe. Before the PE pipe is inserted, a launch pit must be excavated. It is particularly important that this be carried out correctly in order to avoid sagging or raised pipe sections that in extreme cases could result in the new pipeline having a negative gradient. During excavation of the launch pit, it is extremely important to comply with the dimensions shown below.

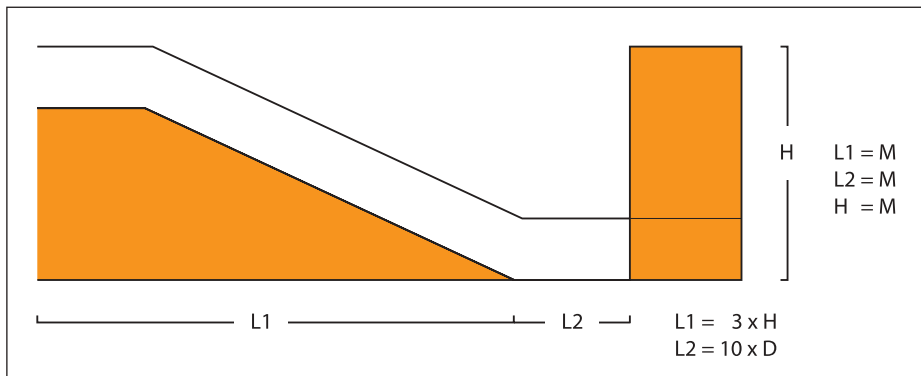

Dimensions that must be complied with when designing a launch pit.



Reception pit.

In addition to the launch pit and excavated lateral connections, pipe bursting without an impact mole requires excavation of a reception pit to which the pipe is pulled and in which the pulling equipment can be located.

This is not necessary with pipebursting with an impact mole. In this case, a cable guide is positioned in the reception manhole to transfer the pulling force from a winch. The combination of winch and impact mole (hydraulic hammer) provides optimum pipe bursting. The wire (or rods when pipe bursting without an impact mole) is lead through the existing pipeline and attached to the bursting head. The new PE pipe is then bolted to the bursting head and the pipe bursting process can begin.

Cable guide positioned in the reception pit.

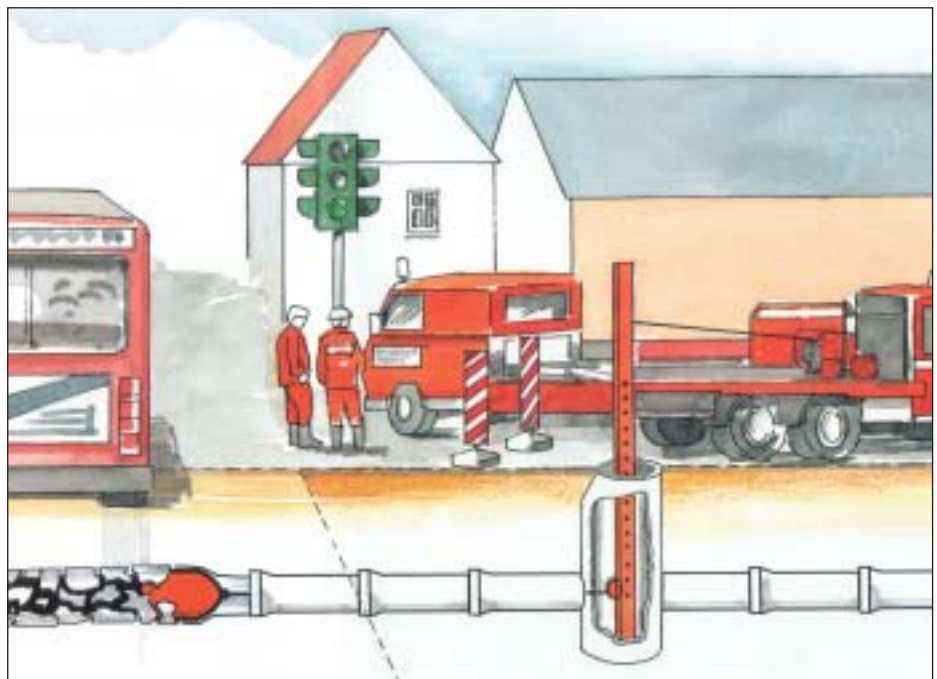

The rate of progress depends on many factors, including soil characteristics, the number of lateral connections, the extent of pipeline up-sizing and the length of the pipeline. A pipe bursting rehabilitation in which approx. 100 m pipeline is to be up-sized from 200 mm diameter BT to 250 mm diameter PEH, PN6 with five or six lateral connections will typically take 5-6 hours. The time taken can vary considerably – from 15 minutes to pipe burst 100 m of 90 mm diameter water pipe to 15-20 hours to up-size 60 m of 600 mm diameter BT to 630 mm diameter PEH, PN6 using pipe bursting techniques.

After the actual pipe bursting process has been completed, the bursting head is removed and laterals are reinstated using special saddle connectors (see photo overleaf) that are fitted to the new PE pipe before a hole for the lateral connection is made with a shell bit. The junction between the saddle connector and the existing lateral (or the new lateral if it has also been renovated by pipe bursting) is sealed with a shrink-on sleeve to make it watertight.

Manhole floors are renovated by laying new channels and thereafter casting new berms. Finally, a watertight seal between the PE pipe and the manhole is created.

Renovating laterals with pipe bursting techniques

Pipe bursting can be used to renovate laterals in the same way as for mains. When pipe bursting a lateral, the pipe is usually inserted from a manhole on the property or by establishing a new boundary manhole. Pipe bursting is performed towards the mains connection. Renovated laterals are connected to the main using saddle connectors (see photo below). Depending on make, these can be fastened in various ways, including bolts, stainless steel collars or electrofusion.

Pipe bursting with short pipes

Basically, pipe bursting with short pipes is performed in the same way as pipe bursting with long, fusion-jointed pipes. However, only one pipe section (e.g. 3 m long) is inserted at a time, after which the process is stopped and a new 3 m pipe section is connected and pulled into the pipeline. The benefit of this method is that the launch pit will be shorter. The drawback is that the method is more time consuming because of the many joints that must be fused and cooled.

12.6 Completion work

After installation, it is often necessary to carry out completion work. This may, for example, take the form of the following:

- Leak testing
- Consumer information following service line reinstatement
- Manhole finishing to ensure continued smooth flow
- Final CCTV inspection to document the completed renovation

The purpose of finishing work is to ensure that tasks over and above actual pipeline renovation are performed and documented in accordance with the contractor's own quality system and to the satisfaction of the pipeline owner.

Fitting saddle connectors to the main pipeline.

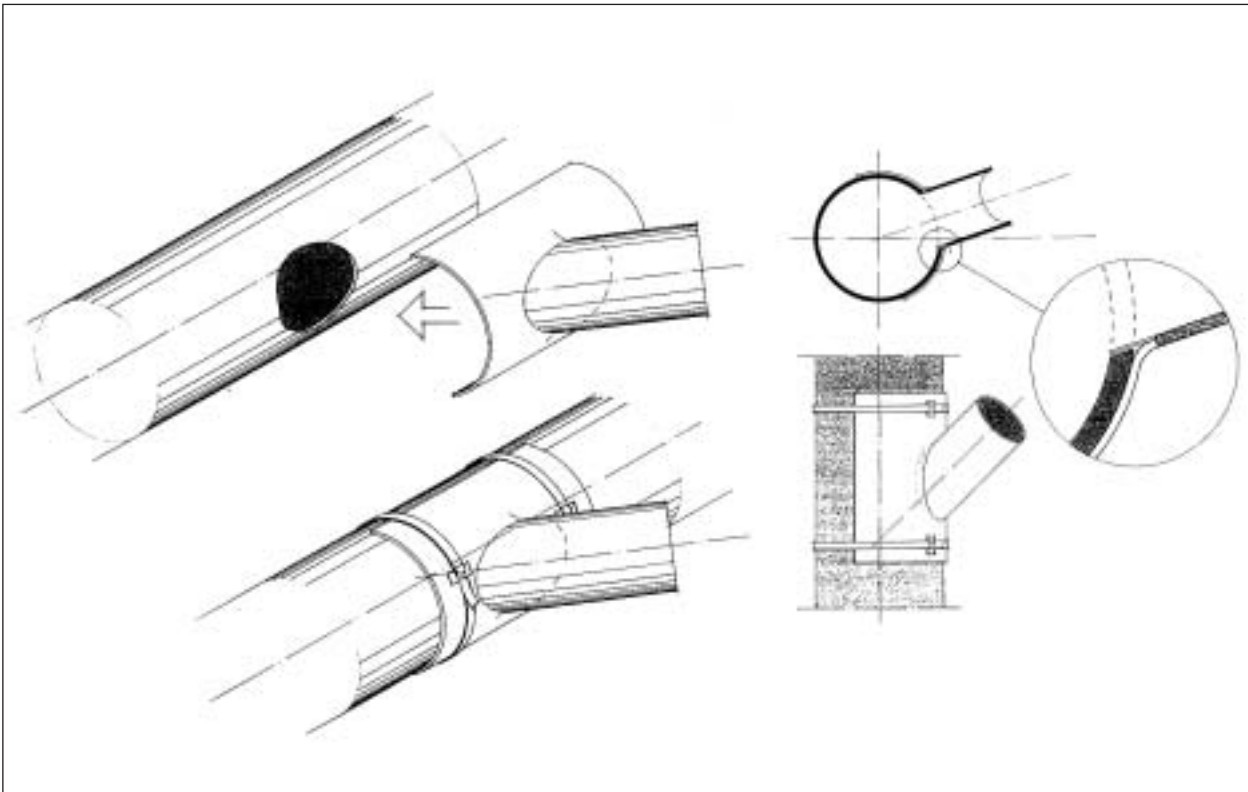



The manhole floor is renovated with a new channel and the berms are subsequently re-cast.

12.7 Quality assurance and documentation

A final quality review compares the documented work performed with the requirements and descriptions of the contractor and any supervising authority. A final review should always be conducted, its purpose being to confirm that work done is in compliance with agreements made.

When a renovation project is completed, the contractor provides the pipeline owner with documentation of the quality of the work performed in the form of a quality manual. In this respect, it is important that during the tendering phase the pipeline owner ensures that such documentation can be prepared and submitted on completion of the renovation work. The quality manual should at least contain or state the following:

- Declaration stating which products/installation methods have been used
- How preparatory work and preliminary surveying have been performed
- Materials handling
- Availability and use of installation manuals
- How supplementary work and final quality assurance have been carried out and documented
- The form of final documentation
- How deviations in relation to the instruction manual have been dealt with
- Complaint processing

PIPE BURSTING

12

METHODS

13.1 Introduction

Since the middle of the 1980s, when directional drilling was introduced in earnest, the technique has been under continuous development. Especially during last ten years its use has become very widespread. The advantages of this type of drilling became plain to everyone: there were large savings to be made and disruption and damage could be kept to a minimum.

Internationally, the method is known as Horizontal Directional Drilling (HDD) or, more shortly, Directional Drilling.

The technique was introduced in Scandinavia at the end of the 1980s and here too rapidly demonstrated how advantageous it was when installing cable conduits and pipes in the ground.

Further development of the technique is conditional on consultants and pipeline owners responsible for a project having good knowledge of the method and on them and the drilling contractors evaluating the application possibilities as often as the opportunity presents itself.

13.2 Applications

Generally speaking the method can be used in all types of ground, from water-saturated sand and gravel to dry and water-saturated clay (not bed-rock of course).

The method was primarily developed for use in connection with PE conduits for cables and pipes.

Today, drilling for telecommunication/broadband networks comprises a large proportion of drilling contractors' work. Many kilometres are drilled every day and often constitute from 5 to 10% of a complete run. The typical pipe size is 40 mm, but directional drilling has shown that it can be used with advantage to enable 20 pipes or more of this size to be pulled at a time.

Gradually, with an increasing number of installations involving telecommunication cables, it becomes more difficult to find alternative runs as no space is available in existing conduits. At the same time, great care is needed during drilling so as not to damage existing lines and cables.

The use of directional drilling today has spread to other types of installations, such as district heating lines, gravity lines, water supply and drainage lines.

The different types of installations are briefly dealt with in the following.

- **District heating lines**
When drilling bores for district heating pipes, it is preferable to insert protective piping to safeguard the insulating jacket. Sometimes it is also possible to install district heating pipes without first using protective piping, but with longer bores the geological conditions must be taken into account, i.e. the ground must be free of stones and it is preferable to drill in "soft" strata that cannot damage the jacket. Furthermore, the clearance between bore and jacket must be filled by injecting a thick mixture of water and bentonite in order to reduce friction between them.
- **Gravity lines**
It is extremely difficult to install gravity lines using directional drilling. A clever contractor using a precision sonde will be able to position a pilot bore with pinpoint accuracy, but it is not possible to measure the position of a PE pipe while it is being pulled through. Consequently it is very difficult to say how accurate a gravity bore can be made, and how large a fall there must be to avoid structural irregularities occurring in the line.
- **Water supply lines**
Directional drilling is eminently suitable for the installation of water supply lines. There are no fall requirements and the major consideration is to maintain the depth over a certain minimum.
- **Drainage lines**
When drilling a bore for drainage lines, a certain fall has to be maintained and this in itself is difficult. Drilling fluids used in connection with installing drainage lines must be either water or a fluid that will in time break down, e.g. a form of polymer.
- **Other pipelines**
In principle, directional drilling is suitable for any type of pipeline installation, but it is imperative that the pipe being drawn through the bore has the required longitudinal strength.

Drilling rigs

There are different models of drilling rigs on the international market. They are usually in one of three categories:

- Mini-rigs, with thrust of less than 20 tons
- Midi-rigs, with thrust between 20 and 40 tons
- Maxi-rigs, with thrust greater than 40 tons

The capacity of a drilling rig is the result of the interrelationship of three different characteristics: its thrust capability, pump capacity and torque. The torque is particularly vital when drilling large bores.

Environmental conditions at the workplace

It is the responsibility of individual contractors to comply with current legislation on the work environment. Examples of the aspects that must be covered are:

- Workplace evaluation
- Safety organisation
- Health and safety plans
- Safety measures
- Safety equipment
- Welfare measures
- Personal hygiene
- Emergency plans
- Handling of possible soil pollution

It should also be borne in mind that in addition to national legislation, local authorities can lay down rules and regulations for many aspects of the work environment.

13.3 Preliminary surveying

To achieve the best possible result of pipeline renovation using directional drilling, it is important to carry out detailed preliminary surveying to determine, at the very least, the following:

- Subsurface and technical environmental surveys
- Water table depth
- Registration of pipelines, cables, and any underground obstructions
- Location and size of launch/reception pits

With directional drilling, knowledge of the type of ground involved is of the greatest importance, i.e. how much sand, clay, or perhaps rock, it contains. It is also important to collect data on the water table in the area.

It is often advantageous to search the archives to find data from previous subsurface surveys performed in the vicinity of the intended pipeline

route. Such surveys are often found in connection with other constructional work in the same area. It is also possible to find information about particular areas in Sweden and Denmark by contacting GSU (Geological Survey of Sweden) or GE-US (Geological Survey of Denmark and Greenland).

When the available information is correlated with the size and type of pipeline to be installed, the appropriate drilling rig, bore head and reamer can be chosen. All the above information is also decisive when determining the composition of drilling fluid.

In addition to verifying the subsurface conditions, it is also important to evaluate the position of the pipeline in relation to other underground constructions. Actual conditions must be considered in order to determine where launch and reception pits are to be located, and what might be above the pipeline when it is installed, e.g. roads, streams, harbours, railways, etc.

A further very important factor in positioning the pipeline concerns the radius of the bends the drilling head must maintain. If the correct radius is not observed, there is a risk of drill pipe fracture and the loss of expensive drilling equipment.

Yet one more factor that can be decisive when determining pipeline route and length, concerns the possibilities presented for laying out and welding/fusing the pipes that will finally make up the pipeline.

13.4 Preparatory work

Launch and reception pits must be excavated, together with holding pits for drilling fluid and drilled-out material. If there is any doubt about where an existing line is positioned, trial excavation is performed to verify its location.

With long bores it is advisable to drill relief holes so the pressure from drilling "mud" cannot be high enough to create a risk of causing uncontrolled uplift and consequent terrain and road distortion.

Where gravity lines are concerned, the terrain above the pipeline route must be levelled so that a theoretical depth can be worked out for the bore head, for every drill rod.

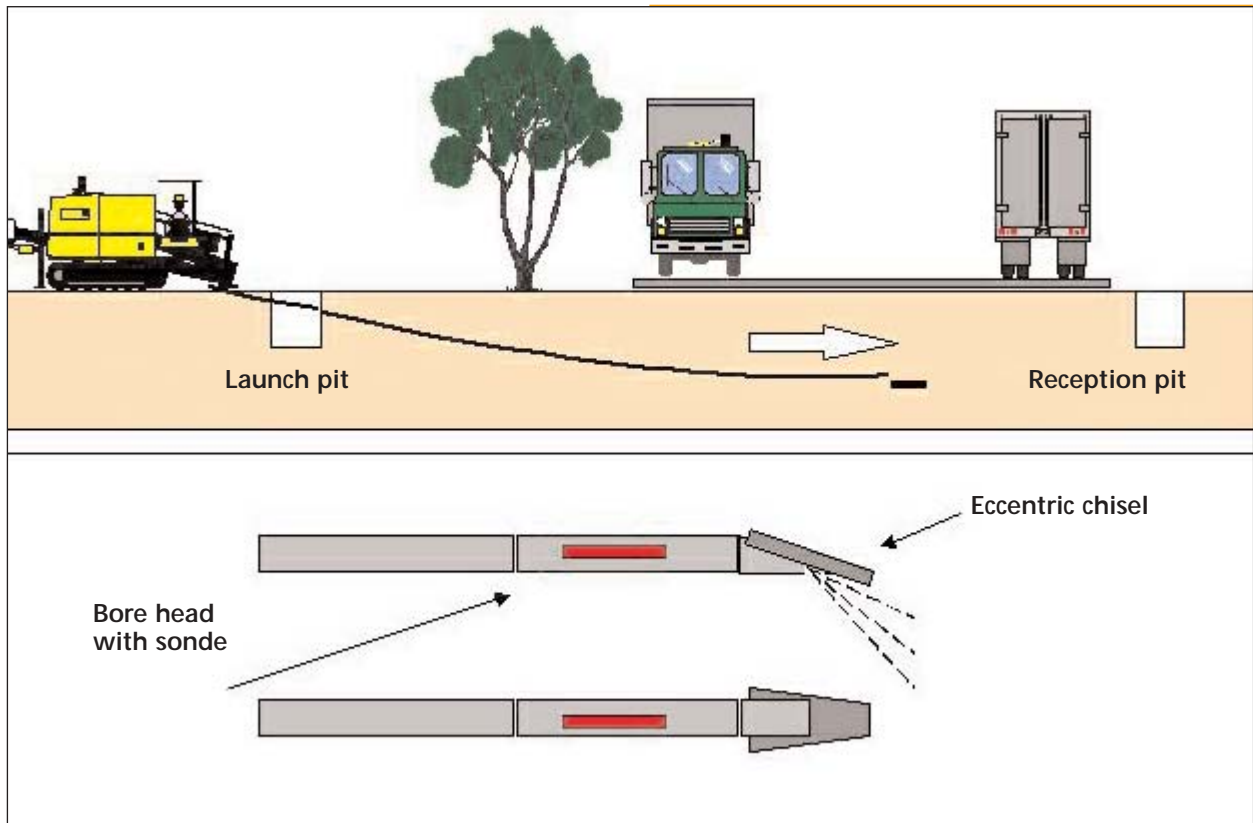

Drilling the pilot bore, and form of conventional bore head.

13.5 Installation

Drilling the pilot bore

The drilling rig is positioned at the launch pit and anchored so that thrust and pull-back forces can be transferred to the bore head. The pilot bore is drilled to follow the planned pipeline route.

The pilot bore is drilled using a steel pipe string that is screwed together and pressed/drilled through the ground from launch pit to reception pit.

The bore head at the front of the drill string can be positioned along a certain line during operation. It is this part of the cycle that has become the name of the whole process: "Directional drilling".

Directional control is performed by pressing the bore head through the ground in the following ways:

- Straight-line motion is gained by rotating the bore head
- The bore head is held in the desired position and is pressed forward until the change in direction is achieved

The drilling fluid pumped through the pilot bore and out through the head flushes the loose

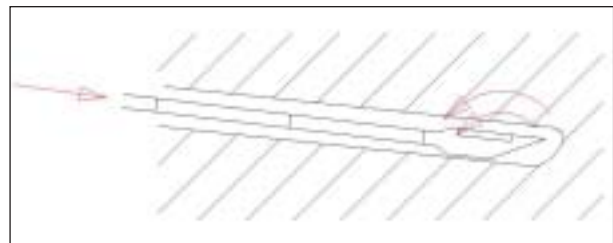

Rotation and pressure produces no change in the angle or direction of the drill head.

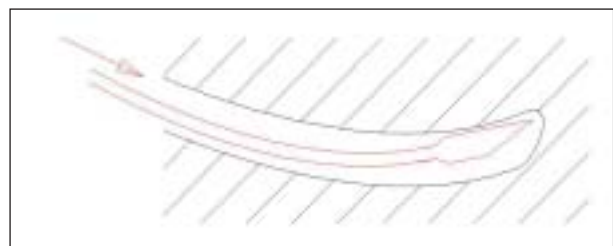

Pressure without rotation produces change in direction.

bored earth back through the space between the bore wall and drill string to a launch pit.

The tip of the bore head normally carries an eccentrically placed "chisel" which is used in unconsolidated and semi-consolidated deposits (post-glacial and glacial deposits).

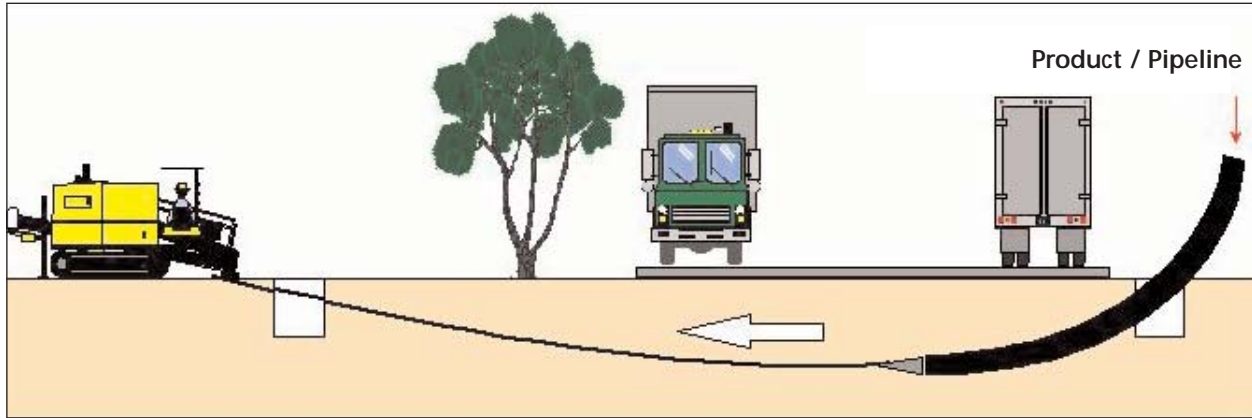

Pulling in the product pipe.

When boring in, for example, rock/primary rock, a diamond or hard metal bore can be used. To remove such hard material, the crown of the bore head is pressed against the rock and at the same time rotated by a fluid-driven motor.

Reaming, and installation of product pipe

After the bore head has reached the reception pit, it is disconnected from the drill string so that a reamer (expander) can be fitted. The product pipe is then mounted on the reamer, complete with swivel connector, and the reamer and pipes are then drawn back. The reamer back-reams the bore oversize to enable loosened material to be transported out of the bore. In difficult ground, and where the bore is long and large, pre-reaming can be necessary.

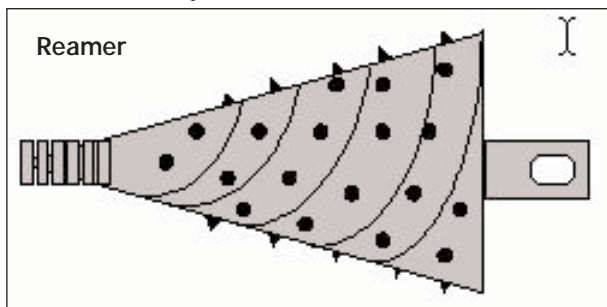

Drilling fluid

Drilling fluid is pumped through the drill string and jets during the whole process.

This means that:

- Surplus earth is transported out of the pilot bore
- Drill string sections and bore head remain cooler because friction between the bore head and earth is reduced
- The pilot bore is stabilised, in that hydrostatic overpressure is created
- A “filter cake” is created on the bore wall and ensures that no drilling fluid escapes into the surrounding earth, and that water cannot infiltrate into the bore

The drilling fluid is a mixture of water and bentonite, sometimes with additives.

Drilling fluid circuit through drill string and return through space between bore wall and drill string

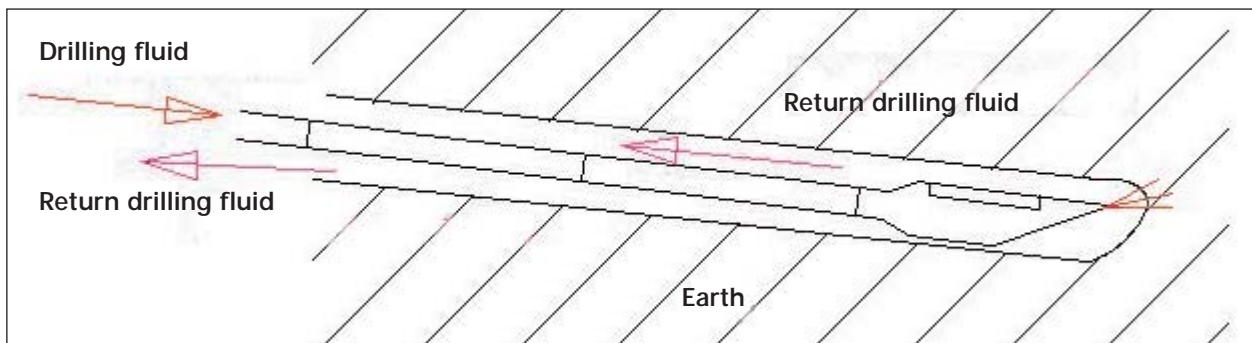

The ratio of bentonite to water normally varies between 2 kg to 40 kg per 1000 litres water, depending on the state of the earth concerned.

When drilling drain bores, a biodegradable polymer can be used.

Tracking and guidance systems

The basis of directional drilling is a system able to determine the position and orientation of the bore head, combined with a mechanical system that enables the operator to change the direction of the bore head so that it follows the intended route.

There are different systems available, each of which fulfils these requirements. However, the most widely used is a "walk over" system in which a sonde is fitted immediately behind the tip of the bore head. The sonde transmits radio signals which are picked up by a receiver held by the "navigator". The navigator knows that the sonde/bore head is vertically below the receiver when the signal is strongest. In this way the X and Y coordinates of the bore head can be fixed. At the same time the receiver is able to read the actual depth, the Z coordinate, of the sonde.

The navigator passes collected information on the depth, incline and orientation of the bore head on to the operator of the drilling rig so that he is able to follow directional changes during the boring. The depth and incline are registered in a journal and are used to calculate the theoretical boring depth.

The fact that radio signals are transmitted through earth means that they are accompanied by a certain degree of error. The inaccuracy of signals increases as a percentage of the sonde depth. With systems normally used for cable duct pipes, the error reading is about 5% or less relative to the depth.

Error signals can also appear when boring is performed in the vicinity of the following:

- Electrical cables, underground or overhead
- Pipe networks
- Railway track
- Sheet piling and metal ramps
- Cross or parallel-reinforced platforms and piling
- Saline water

For larger and more complicated routes such as "crossings" under rivers, fjords, belts, etc. more sophisticated systems are necessary to determine the position and orientation of the bore head. One of these systems uses the earth's gravity and magnetic field, or establishes an artificial magnetic field. Communication between the sonde and drilling rig is via a cable that is led back to the drilling rig. The cable relays the X, Y, Z coordinates and information about the orientation of the bore head. It thus becomes possible to control the bore head at great depths, whereas the limitation of conventional is around 15 metres.

"Walkover" tracking system.

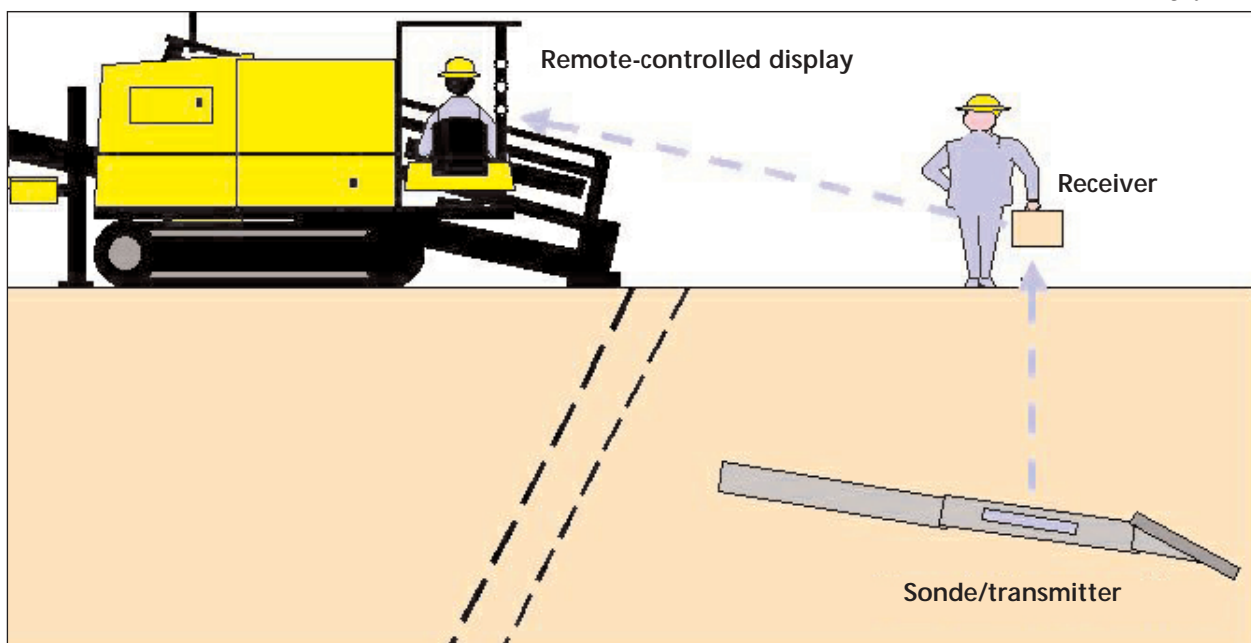

13.6 Completion work

After installation, it is often necessary to carry out completion work such as:

- Leak testing
- Manhole finishing – to ensure continued smooth flow
- CCTV inspection to document the completed renovation
- Infilling of launch and reception pits

13.7 Quality assurance and documentation

A final review compares the documented work performed with the requirements and descriptions of the contractor and any supervising authorities. A final review should always be conducted, its purpose being to confirm that work done is in compliance with agreements made.

On the completion of directional drilling, the contractor provides the pipeline owner with documentation of the quality of the work performed in the form of a quality manual. In this respect, it is important that during the tendering phase the pipeline owner ensures that such documentation can be prepared and submitted on completion of the renovation work. The quality manual should at least contain or state the following:

- Declaration stating which products/installation methods have been used
- How preparatory work and preliminary surveying have been performed
- Material handling
- Availability and use of installation manuals
- How supplementary work and final inspection have been carried out and documented
- The form of final documentation
- How deviations in relation to the instruction manual have been dealt with
- Complaint processing
- Effect of materials on the environment

If the above are covered by a quality manual, the pipeline owner/consultant can be reasonably certain in the selection stage that the quality of the project when complete will be documented satisfactorily.

14.1 Introduction

Historically, all pipeline crossings are pipe jackings, irrespective of whether they consist of ramming small steel pipes with a percussive hammer to displace the surrounding soil, microtunnelling techniques or the jacking in of large pre-fabricated elements to allow a road to pass beneath a railway embankment, for example.

Pipe jacking and microtunnelling can be divided into the following three groups:

- **Steel pipe ramming** (group 1)
This method will be treated separately and briefly as it is not considered to be a true pipe jacking or microtunnelling technique
- **Jacking/drilling pipes** (group 2a)
150-1000 mm in diameter
- **Jacking pipes** (group 2b)
Larger than 1000 mm in diameter
- **Microtunnelling** (group 3)

Steel pipe ramming

In pipe ramming, an open-ended steel pipe is driven through the ground by a hydraulic hammer. The hammer is attached behind the pipe, and the ramming force displaces the soil in the path of the pipe wall.

The pipe becomes filled with spoil as it is rammed through the ground. In small diameter pipes, this can often be removed by flushing, while in large diameter pipes it can be scraped out.

The only means of steering the ramming process is by positioning the launching ramp. This ramp must be carefully constructed with the desired slope. It is not possible to adjust the direction taken during the process, and this technique is therefore very dependent on ground conditions. The pipe may be deflected off course if it meets an obstacle, a large stone for example. Such deflections will probably only be detected when the pipe emerges on the other side of the crossing.

Pipe jacking and microtunnelling

Pipe jacking and microtunnelling belong to the same group of installation techniques for pipes of 150-200 mm diameter or more.

Pipe jacking is defined as a system whereby pipes are installed directly behind a shield machine by hydraulic jacking from a launch pit. The pipes thus form a continuous string in the ground. The pipes, which are specifically designed to withstand the jacking forces used during installation, form the final pipeline once the spoil has been removed.

As a special form of this technique, microtunnelling, is defined as steerable and remote-controlled using a shield for installing pipes with diameters smaller than the permissible minimum for man entry.

Microtunnelling must not be confused with conventional tunnelling, in which the pipeline is formed by connecting shells at the tunnel face.

14.2 Applications

In recent years, modern technology has made it possible to apply both methods under almost all ground conditions – from waterlogged sand or gravel, and dry or waterlogged clay, to solid rock or a mixture of various conditions.

Both pipe jacking and microtunnelling are well suited to situations where a pipeline must form a level line, in that the guidance control system allows accurate installation with great precision. One of the most common applications is for gravity sewers, where not only the line and level are important, but also the depth. In this situation, pipe jacking and microtunnelling are often more cost-effective than conventional open-cut installation.

Most microtunnelling drives form straight lines between pits. Specialised systems capable of curved drives are also available, but as conventional laser equipment cannot be used to steer the machine from the launch pit, alternative alignment systems must be used.

Environmental conditions at the workplace

It is the responsibility of individual contractors to comply with current legislation on the work environment. Examples of the aspects that must be covered are:

- Workplace evaluation
- Safety organisation
- Health and safety plans
- Safety measures
- Safety equipment
- Welfare measures
- Personal hygiene
- Emergency plans
- Handling of possible soil pollution

It should be noted that both national legislation and local authority regulations apply to many of the factors involving the workplace environment.



Schematic illustration of microtunnelling

14.3 Preliminary surveying

The most critical factor in any pipe jacking or microtunnelling project is the geology. A precondition for a successful project is therefore that a thorough survey of local ground conditions be carried out.

There is a risk that a type of machine unsuitable for the task in question will be used if it is

not known in advance which type of ground is to be dug or bored through.

Another important factor in preliminary surveying is the localisation of existing pipelines. This is becoming more and more crucial as the number of pipes and cables in the ground increases and there is uncertainty about their exact location.

To achieve the best possible pipe jacking or microtunnelling, it is important to carry out detailed preliminary surveying to determine, at the very least, the following:

- Geo-technical and eco-technical investigations
- Water table depth
- Registration of pipelines, cables and any underground obstructions
- Location and size of pits

14.4 Preparatory work

Launch pit

The first requirement of a pipe jacking or microtunnelling project is the establishment of a launch pit. The design of the launch pit depends on the choice of installation method, but vertical, shored sides and ends are commonly used. The vertical rear wall is used to absorb the jacking force necessary to drive in the pipe.

Furthermore, the vertical side and end walls of the pit allow correct alignment and anchoring of the jacks during the entire operation. The size of the launch pit depends on the length of the pipes to be jacked into place.

14.5 Installation

Spoil removal in pipe jacking

Several spoil removal techniques are used in pipe jacking. With pipe diameters less than 1000 mm, spoil is removed by using an auger or by water jetting. With pipe diameters larger than 1000 mm, personnel in the pipe can remove spoil from the face manually or mechanically. The simplest technique is conventional digging using an open shield where the operator uses hand tools to remove ground in front of the shield.

Under more demanding ground conditions, an auger or similar equipment may be used. Such systems are often used when excavating behind an open shield in ground conditions that to some extent are self-supporting.

Working above the water table is ideal, but under favourable ground conditions it is possible to cope with a certain degree of infiltration using pumps.

Excavated spoil can be removed using small rail-mounted skips. Alternatively, a conveyor belt can be used to load some kind of hoisting system in the pit itself. Occasionally, a vacuum system that sucks spoil out of the tunnel is used.

Where the ground is not self-supporting, a closed system is generally required. This can sometimes be accomplished by pressurising part of the tunnel.

Spoil removal in microtunnelling

Two predominant systems of spoil removal are employed in the small diameter pipes associated with microtunnelling.

In self-supporting soils it is possible to use an auger to remove spoil. The auger is mounted in a casing within the jacking pipe. The auger feeds spoil back to the pit, from where it is hoisted to the surface in a small skip.

In more difficult ground conditions or where the groundwater table is higher, a slurry system is often used.

The slurry system requires a suspension of bentonite to be pumped in from the surface through the cutting head via a piping system. If necessary, the slurry is pressurised to maintain face support. The bentonite suspension mixes with the spoil in the cutting head, and the mixture is pumped to the surface where it is cleaned and treated in a recirculation unit which removes all large particles from the slurry and recycles it through the system.

The slurry system has the advantage of being continuous, while auger-based methods involve several operations, including hoisting all spoil out of the pit.

Reception pit

Both microtunnelling and pipe jacking require a reception pit.

The pit must be large enough to allow the shield used to be removed without problems. Reception pits do not require particular strength; their only purpose is to allow the removal of remaining equipment.

Jacking frames

Pipes are jacked in from an hydraulic jacking frame located in the launch pit. The frames are designed to regulate the level of jacking force required by the shield on any given project.

This force is determined by local ground conditions.

Steering

In most cases, pipe jacking operations are steered using laser technology, which allows the operator to precisely determine the position of the pipe face. Line and grade tolerances are assured throughout the entire operation by continuous control and, if necessary, horizontal or vertical adjustment of the face. Line and grade tolerances of 30 mm are usual for laser-based steering under normal conditions.

In contrast to laser equipment, gyroscopic devices allow curved crossings to be installed.

Microtunnelling launch pit. Jacking a fibreglass pipe.



Pipes

A wide range of pipe materials is available for installation using pipe jacking and microtunnelling techniques.

The choice depends on the requirements of the pipeline owner, ground conditions, transport costs and pipeline length. Materials include reinforced and non-reinforced concrete, fibreglass, steel, cast iron and plastic.

The majority of pipeline owners and consultants require that pipes used in pipe jacking and microtunnelling be certified in compliance with ISO 9002.

One of the most important aspects of pipe quality is the pipe face. If the pipe face is not completely perpendicular to the pipe axis, the force will be applied asymmetrically, resulting in tension and possibly fracture.

In addition to this aspect of pipe quality assurance, special rubber rings must be inserted between the pipes during installation, partly to improve the distribution of the force applied and partly to prevent water infiltration.

Pipes used for microtunnelling and pipe jacking must have the same diameter throughout, in contrast to traditional pipes that become thicker at joints. This is of importance in maintaining low friction on the pipe during the jacking process. Pipe lengths vary from system to system, but lengths of between one and two metres are common. As the joint is the most expensive part of a pipe, the use of long pipes reduces costs. This must, however, be weighed against the need for a larger launch pit.

Lubrication

The two greatest forces which need to be overcome when jacking a pipe through the ground are the weight of the pipe string and the friction between the surface of the pipe and the ground as the pipe moves forward. Friction increases with pipe diameter, since larger diameter means larger surface area.

The introduction of lubrication using a bentonite mixture, so-called drilling mud, has reduced this friction considerably. Bentonite mixtures are specially designed to suit different ground conditions. For example, a thicker mixture is required in coarse-grained soils where the drilling mud can more easily drain away through the porous material than in clay soils where a thinner mixture is preferable.

The drilling mud is pumped through the tunnel bore in pipes and injected through the pipe walls by means of small holes drilled around the whole circumference of the pipe wall. Injection is usually controlled centrally from a mixer station beside the launch pit. Nowadays, drilling mud injection is often computer controlled so that the pressure and quantity of mud injected through each nozzle can be regulated. In this way, optimum pressure can be maintained along the entire pipe string, thus saving not only superfluous drilling mud but also reducing the energy required to drive the pipe string forward.

14.6 Completion work

After installation, it is often necessary to carry out completion work. This may, for example, take the form of the following:

- Leak testing
- Manhole finishing to ensure continued smooth flow
- CCTV inspection as documentation of renovation work completed
- In-filling of launch and reception pits

14.7 Quality assurance and documentation

A final review compares the documented work performed with the requirements and descriptions of the contractor and any supervising authorities. A final review should always be conducted, its purpose being to confirm that work done is in compliance with agreements made.

On the completion of pipe jacking or micro-tunnelling, the contractor provides the pipeline owner with documentation of the quality of the work performed in the form of a quality manual. In this respect, it is important that during the tendering phase the pipeline owner ensures that such documentation can be prepared and submitted on completion of the renovation work. The quality manual should at least contain or state the following:

- Declaration stating which products/installation methods have been used
- How preparatory work and preliminary surveying have been performed
- Materials handling
- Availability and use of installation manuals
- How supplementary work and final inspection have been carried out and documented
- The form of final documentation
- How deviations in relation to the instruction manual have been dealt with
- Complaint processing
- Effect of materials on the environment

If the above are covered by a quality manual, the pipeline owner/consultant can be reasonably certain in the selection stage that the quality of the project when complete will be documented satisfactorily.

15.1 Introduction

A sewer system is part of a country's infrastructure. It is used for transporting wastewater and surface runoff from their sources to where they are treated in wastewater treatment plants or discharged to recipients.

The transportation system traditionally consists of pipelines, laterals, manholes and various special components like pumping stations, basins, overfalls, etc.

In Denmark, it is estimated that there are some 1.6 million manholes on the sewer network. Many of these are in such poor condition that they leak, resulting in both wastewater exfiltration, which burdens the environment, and groundwater infiltration, which burdens pumping stations and wastewater treatment plant.

Experience shows that 6-8% of these manholes should be renovated within the next few years and that the maintenance and renovation of the remainder should be planned and implemented over the lifetime of the network.

There has been increased interest in manhole renovation over the past few years, but the renovation of this part of the sewer system still lags behind that of mains and laterals.

15.2 Applications

In recent years, much effort has been spent on developing and improving renovation methods for manholes on the sewer network. This has resulted in a range of methods being made available to pipeline owners. The development of techniques is ongoing, and new, improved methods of assuring manhole condition are expected to be introduced in coming years.

15.3 Manhole renovation handbook

The handbook *Methods of Manhole Renovation (Metoder til Brøndrenovering)* (see references) was published in 1997. It was prepared jointly by a number of Danish municipal authorities and industrial companies with financial support from the Danish Agency for State and Industry. The book, and the responsibility for its distribution, was subsequently transferred to SSTT.

The handbook provides an overview of products currently available for the renovation of manholes, and contains the addresses of suppliers and contractors. The handbook also provides assistance in the classification of manholes in relation

to their condition in order to assist in selecting the best renovation method in specific situations.

All methods are described in the handbook in the same way, under the following headings:

- Materials
- Implementation
- Material properties
- Environmental assessment
- Technical data
- Product assessment
- Resistance
- Approvals
- References

"Metoder til Brøndrenovering" provides a good overview of accepted renovation methods, etc., and can be obtained by contacting SSTT at (official address) or on the Internet at www.sstt.dk.

15.4 Renovate or decommission?

In any sewer rehabilitation project, it is necessary to consider whether manholes should be preserved and thus renovated, or decommissioned.

In recent years, several tools and techniques for inspecting, operating and maintaining sewer systems have been developed. Therefore, the number of manholes now required is much lower than it used to be.

Additionally, out of regard for the work environment and health and safety factors, personnel should be sent down manholes as little as possible.

However, while manholes are still an absolute necessity for the inspection and maintenance of sewer systems the above developments have made it both reasonable and justifiable to space manholes further apart than was previously common. Furthermore, critical review and assessment of sewer systems often results in the decommissioning of a number of manholes in an area.

Hydraulically, most manholes create resistance, and therefore contribute to reducing the capacity and reliability of the sewer system as a whole. This factor should also be taken into consideration.

15.5 Measurement and registration of manholes

All sewer authorities should have an overview of their sewer systems, including the registration and numbering of all manholes.

Inspection and classification of all manholes should be carried out in connection with sewer renovation work. This can be performed by visual assessment, CCTV inspection or digital surveying equipment.

Visual assessment, sometimes supplemented by CCTV inspection, is commonly used, but it is also possible to use specially developed measuring equipment to digitally register manholes in the form of a complete three-dimensional picture, including floor, berms, defects, etc.

Such digital registration can be transferred direct to a database, and thus provides a sound basis for assessing manhole condition, and for planning and implementing repair and renovation work.

Manholes should be classified on the basis of a uniform scale, which may be graduated as required. The simplest method is to use the grades good, average and bad, where bad means that the manhole should be renovated immediately and average means that it should be kept under observation.

A set-up for measuring and registering a manhole in one operation is shown below.



15.6 Manhole defects

Manholes consist of two sections: the floor and the shaft. The defects encountered in the two areas are often of different type. Subsequent renovation work can be prioritised on the basis of the extent of the defect and its location in the manhole.

A standard manhole is shown in the illustration below. Manhole components are indicated on the left, and several common defects in individual components are shown on the right.

Attention should be focused on the following defects during manhole inspection:

- Infiltration
- Corrosion
- Precipitation
- Displaced joints
- Cracks and fractures
- Defective/no floor
- No berms
- Poor flow
- Deposits
- Defective ladder
- Defective cover

Some manhole defects are found throughout the manhole, while others only affect part of it.

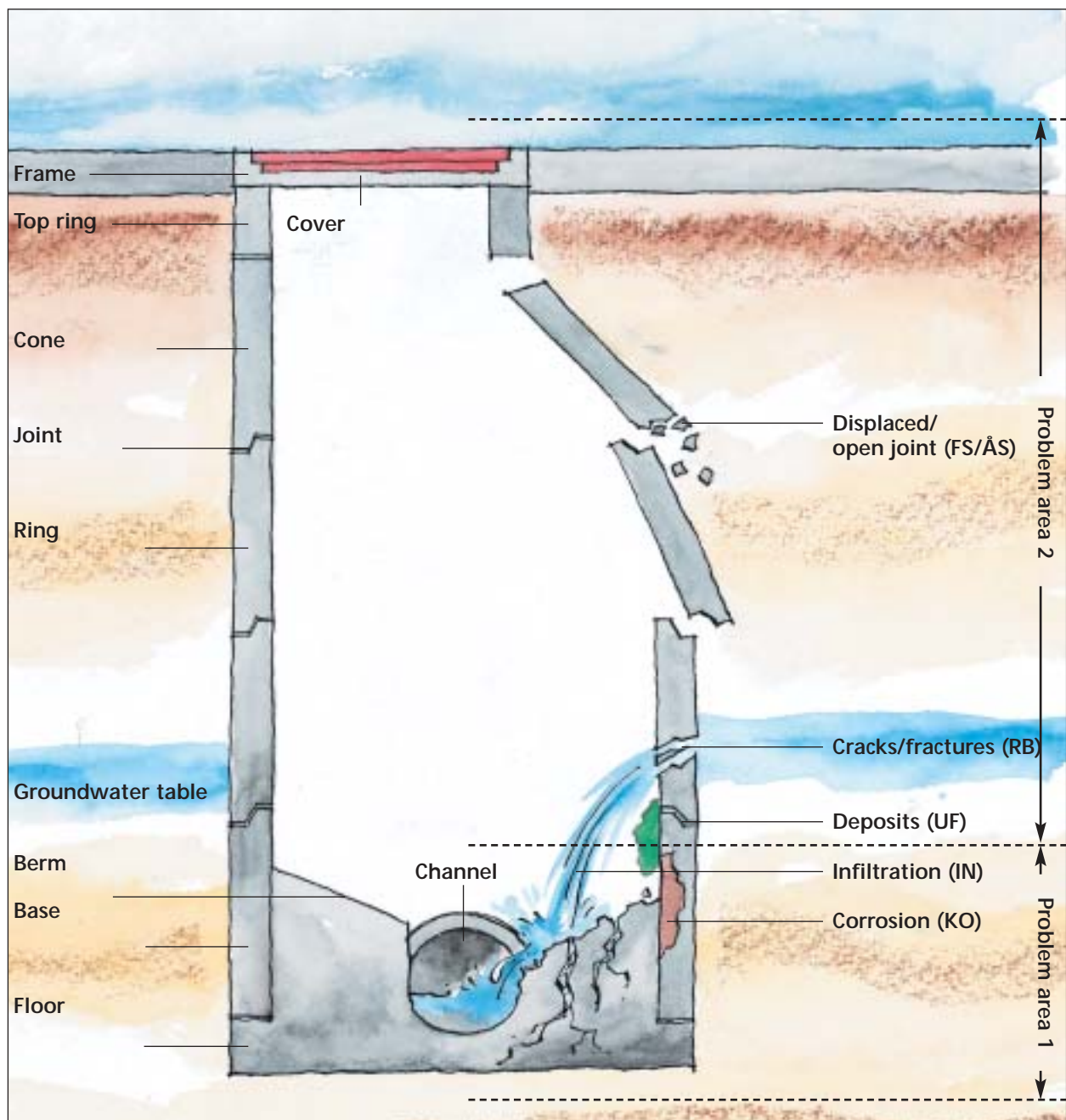

Corrosion, for example, typically attacks the part of the manhole above the water level.

Other defects are typically found in limited areas in the manhole. Leaks, for example, are most often found in joints.

The most common manhole defects are grouped for area 1 (manhole floor) and area 2 (manhole shaft) and are described in the following table.

Defects are usually concentrated in the lower part of the manhole because the critical points are often the connection between pipe and manhole, and the manhole floor.

There are two main problems in manholes: leaks (causing infiltration/exfiltration) and decay (causing weakening). In both cases, the size of the problem is determined by the extent of the defect and its cause. Infiltration increases the water quantity, and if the hydraulic properties of the manhole are also reduced by decay, the capacity of the sewer system as a whole is reduced.

It can be beneficial for manhole owners to group manholes according to defect type and extent. Similarly, the combination of defects occurring should also be included in the classification.

Defect	Manhole floor incl. berms	Manhole rings and cone
Corrosion KO	Hydrogen sulphide attacks above the water level. The floor may therefore remain intact while the remainder of the manhole is subject to corrosion.	Hydrogen sulphide attacks above the water level. The floor may therefore remain intact while the remainder of the manhole is subject to corrosion.
Cracks/fractures RB	Cracks and fractures typically occur as the result of poor construction, inferior materials and/or outside influences. They result in leaks. Depending on their extent and location, cracks and fractures will reduce manhole strength and impair function.	Cracks and fractures typically occur as the result of poor construction, inferior materials and/or outside influences. They result in leaks. Depending on their extent and location, cracks and fractures will reduce manhole strength and impair function.
Displaced joints FS	Displaced or open joints occur for the same reasons as cracks and fractures. Manhole strength remains unaffected, but leaks result.	Displaced or open joints occur for the same reasons as cracks and fractures. Manhole strength remains unaffected, but leaks result.
Deposits UF	Deposits often result from the action of aggressive groundwater. Lime is leached from the concrete, resulting in leaks and manhole weakening.	Deposits often result from the action of aggressive groundwater. Lime is leached from the concrete, resulting in leaks and manhole weakening.
Infiltration IN	Infiltration presupposes the presence of leaks and groundwater. All the above-mentioned defects can cause infiltration. Typically, leaks result in greater quantities of water being delivered to water treatment plants, thus reducing their efficiency. Exfiltration of wastewater may occur if the groundwater table is below the manhole.	Infiltration presupposes the presence of leaks and groundwater. All the above-mentioned defects can cause infiltration. Typically, leaks result in greater quantities of water being delivered to water treatment plants, thus reducing their efficiency. Exfiltration of wastewater may occur if the groundwater table is below the manhole.

The following parameters should be used to prioritise when and how individual manholes are renovated:

- Manhole strength (risk of collapse)
- Manhole capacity (flow)
- Floor tightness
- Shaft tightness
- Corrosion protection
- Top rings/covers

Defects differ greatly from manhole to manhole, and the renovation method used must be adapted to suit the manhole in question.

15.7 Methods

An overview of the various principles for manhole renovation is given in the following. More specific details are available in *Methods of Manhole Renovation* or can be obtained from individual manufacturers.

The traditional method

In this method, an "ordinary" craftsman or contractor is requested to renovate the manhole using traditional methods. Decaying areas are first chipped away, and then re-plastered using quick-drying mortar. If floor channels and berms are to be repaired, the manhole must first be drained.

Reasonable results can be achieved with this method if the work is performed carefully, the right mortar is used and the manhole is completely drained. It is difficult to achieve a satisfactory result when groundwater infiltration is the problem. However, in this instance, it may help to lower the groundwater around the manhole using one or two suction points or by drilling a suitable number of drain holes to relieve water pressure until the manhole has been repaired. The drain holes are subsequently plugged.

This method is seldom used when a manhole is to be completely renovated, but is used for partial renovation or repair. The method can provide the required result, but it is very dependent on the tradesman who performs the work.

Lining

A fibreglass liner, designed especially for renovating manholes, is now on the market. Because of its special form, this liner adapts to the conical shape of the manhole and to a certain extent the floor channel and berms. The method allows the entire manhole to be renovated in one operation.

Panels and elements

Several systems are available in which panels or elements are fitted to the manhole walls, and in some cases also to cones and berms. When the panels have been securely attached, cavities are filled with a special grout, foam or similar product.

The panels or elements are made of polyester, fibreglass-reinforced polyester, polyethylene, PVC, etc.

The manhole floor is similarly renovated using panels or pipe halves laid in grout. Alternatively, a completely new concrete floor can be cast.

The method is usually rather expensive, but for large custom-built manholes it may be the only solution available apart from conventional repair using concrete or masonry.

Manhole inserts

In this method, a smaller manhole is constructed within the existing manhole.

Usually, the existing manhole floor is removed and a 315–600 mm PVC or PE manhole insert is installed and connected to the pipeline using standard pipe joints.

The cavity between the insert and the original manhole is then filled with concrete or grout, and the opening is completed either by grouting beneath the existing manhole cover or by fitting a replacement cover that fits the new manhole size.

The advantage of this method is that it provides a new manhole that is completely watertight. The disadvantage is that manhole size is reduced. The method can only be used in situations where the sewer traverses the manhole in a straight line, and cannot be recommended for deep manholes.

Grout injection

This method is used for manholes that leak, and consists of injecting expanding grout at high pressure into joints and the cavities behind the walls of the manhole, through cracks or a number of specially drilled holes.

Following injection, the manhole sides and floor are renovated as required.

It has sometimes proved beneficial to first inject polyurethane foam through the cracks in order to prevent water from infiltrating. Subsequently, an epoxy grout is injected through drilled holes. This method economises on the use of expensive expanding grout because the relatively cheap foam fills any cavities. The grout, subsequently injected, compresses the foam and permanently seals the leaks.

Spray lining

In these methods, a layer of grout is sprayed at high pressure on the inside surfaces of the manhole, thus providing the manhole with strength and tightness.

Both cement grouts and epoxy grouts are used, as well as more flexible polyurethane products.

The grout usually sets while the surface is being treated and forms a slightly undulating but very smooth surface. These methods make the manhole construction watertight, provide good hydraulic conditions, and allow easy cleaning of manhole surfaces.

The methods are easy to use, and are suitable for complete manhole renovation.

16.1 Introduction

Today, the development of the IT infrastructure is highly important in many countries. In an international context Scandinavia is well advanced in the field of telecommunication and considerable resources are being devoted to its continuing development. In Sweden the vision is that by the year 2005 there will be a complete network with permanent Internet connections offering a minimum capacity of 5 Mbit/s to everyone throughout the nation. Most Swedish municipalities today are extending their fibre cable networks. Backbone networks (rural town networks), regional networks (city networks) and access networks are today being installed with built-in redundancy and as open networks. With these facilities, town networks are able to provide full access to all services offered.

16.2 Applications

The utilisation of the sewerage system as “cable conduits” can in certain circumstances be advantageous where excavation will lead to significant expenditure and disturbance – primarily in large towns where in many central areas there is often so little space that it is not possible to bury new cables without considerable disruption.

Sewers are expected to have a service life of between 60 and 100 years, while the life of telecommunication cables is around 20 years. These figures indicate that when using sewer lines as cable carriers, it is desirable that cables be laid in a way that permits their complete removal at the end of their service life.

The method must be regarded as a supplement to other methods of cable laying, in that the hierarchical tree structure of a sewerage system does not fulfil the ring structure requirements usually demanded by a telecommunication network.

The operation of a given sewerage system might also be affected significantly when cables are led through it. Each individual project should therefore be evaluated while keeping an eye on possible future operational developments.

Experience with the use of this method is limited in comparison with traditional cable laying methods and is confined mainly to large cities in Europe, USA, Canada and Japan. Projects using this method but on a smaller scale are taking place in Copenhagen and Ishøj, Denmark.

General preconditions

Where cables are to be fixed into position by a robot, manholes must have a minimum diameter of 1 m. Smaller manholes can only be used where the cable is laid loose in the bottom of the sewer without fixing.

With “destructive” fixing methods, i.e. where pipe walls are drilled for cable fixings, no effective methods have been developed for fixings in such materials as thin-walled plastic pipes or cured-in-place liners. However, it is expected that a combination of expansion fixing and a suitable adhesive will solve the problem.

Unsuitable pipelines

The following are examples of sewer lines not suitable for hosting cables:

- Damaged pipes that must be first renovated or renewed
- Smaller lines, i.e. they must have a diameter larger than 200 mm
- Pressure lines, in that they are usually small and water flow velocities high with a high degree of turbulence that can present a risk of cable damage
- Supply lines to pump stations. The mode of operation of pumps produces large variations in water flow and level which can impair certain forms of cable fixings
- Laterals are small with many changes of direction. The main risk here is that cables in the pipe can present the risk of frequent blockage

Reduction of sewer line capacity

Laying cables in sewer lines reduces the pipe cross-sectional area and thereby the capacity of the line.

Cable positioning can also give rise to operational disturbances in the sewerage system. Cables must be positioned with care and not where hydraulic or operational characteristics make lines unsuitable as cable carriers.

It must be assumed that each section of a pipeline must be evaluated to determine whether the overall capacity of the line is sufficient to allow cable laying through the pipes.

Cables can cause a further problem. If they are allowed to hang, even slightly, material or debris can become lodged behind them and accumulate. This in turn can lead to blockage.

The incorrect installation of equipment in a manhole, e.g. junction boxes, etc., can create very large reductions in the hydraulic capacity of the manhole.

Very high water flow velocity in combination with loose cables is another source of problems: the cables are tossed around by turbulence. This problem is known in Tokyo where rapid cable wear has been observed.

16.3 Cable fixing methods in sewer lines

Telecommunication cables have an expected life of around 20 years, but such is the rate of development that in terms of technological capability they will become outdated earlier. It is therefore always recommended that fibres of the best quality be used so that technological upgrading will be possible.

A fault in an optical fibre cable laid in a sewer cannot be repaired, and necessitates the replacement of a stretch of cabling between two manholes.

Laying cables in sewer lines can be performed at the rate of about 300 m per day.

Cables laid loosely in the bottom of sewer lines

The simplest method of laying cables in sewer lines is to lay them loose in the bottom and merely anchor them at manholes so that they cannot cause blockage in a manhole. Such cables must be sheathed, in that they must withstand being gnawed by rodents. Cables also have a tendency towards causing deposition and consequent risk of blockage. This applies especially to wastewater lines and combined systems. Experience from Denmark, e.g. Ishøj and to some extent Copenhagen confirms the fact.

Cables fixed in the bottom of sewer lines

If cables are to be laid in the bottom of a sewer line, they should be fixed in position, as recommended by various authorities in, for example Japan. This is especially relevant to lines in areas where rainfall is heavy and water flow velocity can become high.

When water flow velocity is high, the turbulence created results in unfixed cables being tossed from side to side. This results in cable wear which can be avoided by fixing. Wastewater discharged into the mains from laterals also contributes to cable wear.

Cables fixed to the roof of sewer lines

A system has been developed in which is based on clipping a steel-reinforced cable to the roof of the sewer. The clipping itself is performed by a purpose-built robot (shown in the photo below).

The robot drills a 15 mm deep 6 mm diameter hole in the sewer pipe wall. It then clips the cable in position by pressing a plastic hook around the cable and up into the hole. A clip is installed in this way every 1 to 1.5 metres.

Using the robot, a work team is able to install about 300 m of cable per day in pipes of 200 mm diameter or more. It should be added that in Berlin, Germany, the minimum stipulated pipe diameter is 250 mm in order to avoid the risk of the maximum capacity limit being exceeded.

This method can be used to fix cables to any known material. In the case of thin pipe-walls, plastic materials, lining, etc., holes are drilled and an adhesive is used to fix the hooks. With thick-walled pipes the holes are drilled and the hooks inserted, but in this case they are retained by friction. The method has been tested by flushing at 400 bar.

No reports describing experience with cable installation in thin-walled pipes are available.

*Robot for installing cables in the roof of sewer lines.
Source: Robotics Cabling.*

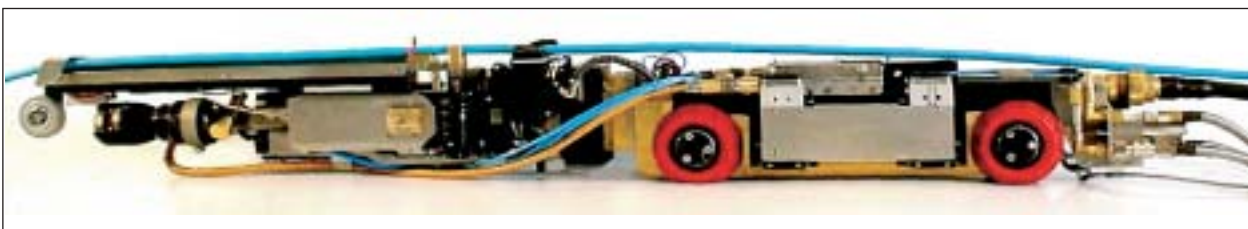

Cable installed behind cured-in-place liners

A variant of the method consists of installing a cable and then inserting a conventional cured-in-place liner. It has been proved that during the curing process the liner temperature can be held low enough to avoid harming the cable. All that is required is longer curing.

Work in Berlin, Germany, has shown that the static strength of CIPP liners is sufficient, even when they are subjected to bulging as a consequence of the cables being installed in the roof of the sewer.

The costs involved mean that this method can only be considered when the decision to install a cured-in-place liner has already been made.

Here, a further variant would be to fasten the cable to the roof of the sewer using adhesive before renovation with a cured-in-place liner.

Miniduct installed in the roof of the sewer, behind the cured-in-place liner

Another method involves a miniduct (a conduit) combined with the cured-in-place liner. The miniduct serves to prevent the cable from being overheated and also facilitates cable positioning. The advantage here is that cables can be replaced by merely pulling another one through the miniduct.

Cables anchored at manholes and tensioned along the roof of sewer lines

In another installation technique, the cable is pulled through the pipeline, anchored at manholes

and then tensioned along the roof of the sewer. The method offers the advantage of making installation inexpensive, fast and simple.

Cables in conduits fixed to the roof of sewer lines

For cables in conduits, a system has been developed in which steel conduits are clipped onto the roof of the sewer. The cables then laid need no steel sheath as they are protected by the conduits.

This method has been further developed in Hamburg, where 30 km of cable has been laid by robot.

The precondition for using this method is that the robot can access the sewer through a 1000 mm diameter manhole.

The first step in using this method is flushing the sewer. It is then inspected using CCTV to establish whether any damage is present that must be repaired before cable laying, and to determine where the cable is to be laid.

The robot fixes stainless steel rings in the sewer at a pitch of 1 to 1.5 m. Wedges are used against the sewer walls to fix the rings. In other words, no drilling, clips, etc. are necessary.

The steel rings carry clips (up to 9) and after a number of conduits have been pulled through the sewer, the robot fixes them into the clips so that the conduits now sit under the roof of the sewer.

Steel ring with conduit clips for installation in the sewer. Source Alcatel.



Finally, fibre optic cable is blown through the conduits and is anchored at manholes.

The robot is capable of installing about 100 m of cable in sewers per day per shift.

The system has been tested by flushing at pressure up to 150 bar without damage to fixings or cables being observed.

Finally, all steel used in this application is acid-resistant stainless.

All fittings and conduits can be dismantled if it becomes necessary.

A new technique of inserting conduits in sewer and water lines is also available and has been met with great interest among Swedish installers. The method exploits the advantages of NO-DIG technology using cured-in-place liners.

Conduits are integrated in the liner at the factory and the fabric is impregnated in the normal way. After normal inversion and curing the result is a new self-supporting line including the conduits for fibre optic cable.

16.4 Evaluating the different methods of installation

A general evaluation of the advantages and disadvantages of the different methods of installation is provided in the table overleaf.

16.5 Operation and maintenance

The conclusion is that where cables are installed in the roof of sewers the risk of blockage is less than when cables are laid in the bottom.

Flushing, root cutting and mechanical cleaning are commonly used to clean sewer lines. Of these, only flushing is suitable when cables are laid in a sewer.

Pipe bursting, short-pipe relining, including cured-in-place lining, involves curing with heat. These techniques cannot be used when cables are laid in a sewer line.

Increased maintenance can be expected on sewer lines in which cables have been laid. Certain cable maintenance costs can also be expected to rise.

16.6 Application guidelines

On the basis of evaluation of sewer networks and installation methods. The use of sewer lines as cable carriers can be recommended on the following conditions:

- Laying cables loosely in the bottom of a sewer line is feasible only where the line is used exclusively for rainwater
- Fixing cables to the roof of a sewer line – whether by clipping, by using conduits, or tensioning – can be used in wastewater and combined installations
- None of the methods described above can be used in pipes smaller than 200 mm. Where pipes are smaller than 250 mm, all details must be examined before using a particular technique on a wide scale
- Cables must not be laid in laterals since these are, typically, smaller than 200 mm. Instead, they should be buried or underbored
- Cables are fixed to the roof of a sewer when cured-in-place lining has already been planned for the stretch of sewer in question
- Constant information monitoring is necessary to see whether new and suitable methods of cable laying in sewers have been developed

Evaluation of advantages and disadvantages of different methods of installation.

Method	Advantages	Disadvantages
1 Cables laid loosely in the bottom of sewers	Easiest and cheapest method. Cable can be easily removed when maintenance work is performed on the sewer. Does not require the use of a robot.	Can obstruct flow – especially in wastewater and combined installations. Increased flushing costs. Requires steel-reinforced cable. Can give mechanical wear problems. Not suitable for multi-cabling as this may obstruct flow.
2 Cables fixed in the bottom of sewers	Partially protected against wear as the cable cannot move.	Can obstruct flow, especially in waste-water and combined installations. Requires steel-reinforced cable. Requires the use of a robot. Cable must be abandoned in the event of cable fault. Cable must also be abandoned when work on the sewer is performed. Not suitable for multi-cabling (obstructive, see above).
3 Cables fixed in the roof of sewers	Protects against mechanical wear.	More expensive than the two above-mentioned methods. Requires steel-reinforced cable. Requires the use of a robot. Cable must be abandoned in the event of cable fault. Cable must also be abandoned when sewers are totally renovated.
4 Cables installed behind cured-in-place liners	Protects against mechanical wear. Plain cable can be used. Cheapest method if sewer is to be lined anyway before cables are laid.	Generally an expensive method because of the need for a liner.
5 Miniduct fixed in roof of sewers behind cured-in-place liner	Protects against mechanical wear. Plain cable can be used. Cable easy to remove for maintenance work or because of cable fault. Extra flushing not required. Rapid installation.	Requires cured-in-place lining of the sewer. Requires the use of a robot. Conduits may have to be abandoned when sewer maintenance is performed.
6 Cables anchored at manholes and tensioned along the roof of sewers	Rapid installation. Cable easy to remove for maintenance work or because of cable fault. Does not require the use of a robot.	Requires steel-reinforced cable. Hanging cable increases risk of blockage.
7 Cables in conduits fixed to roof of sewers	Plain cable can be used. Protected against external factors such as rodents and wear. Cable easy to remove in the event of cable fault.	Most expensive method in terms of installation costs. Increased flushing costs. Conduits may have to be abandoned when sewer maintenance is performed. Requires the use of a robot.

Comments on individual methods

The following guidelines are recommended when cables are to be laid in a sewer line:

- Method 1 – laying cables loosely in the bottom of a sewer and anchoring them at manholes. Should only be used in sewers devoted exclusively to rainwater
- Method 2 – cables fixed to the bottom of sewer lines – should not be used since fixing to the sewer roof is much the best method
- Methods 3, 6 and 7 – fixing cables in the roof of sewers. These methods can be used in all types of lines. The choice will be determined by price and on whether conduits are to be used
- Methods 4 and 5 – fixing cables in the roof of sewers, behind cured-in-place lining with or without miniducts. Can be envisaged when cured-in-place lining has already been planned for the stretch of sewer in question

Cables should not be laid in laterals or other lines less than 200 mm in diameter. The consequences of doing so must be examined before using a particular technique on a wide scale.

Polyethylene (PE) was one of the first materials used to manufacture pipes for lining existing pipelines. PE pipes were used to line existing pipelines as early as the 1960s, i.e. long before the development of pipeline rehabilitation techniques began in earnest. Much has happened over the intervening 30 years, both with regard to the development of PE materials and lining techniques. This chapter describes the properties and classification of PE pipes currently in use, and describes the pipes normally used in the various NO-DIG techniques.

17.1 Material properties

Formerly, PE pipes were designated PEL, PEM or PEH pipes, where the last letter referred to the density of the material – L for low, M for medium and H for high. However, this classification became superfluous when improved material properties allowed higher stress to be used with some PE materials. It has therefore become more usual to designate PE materials with a number, which refers to the long-term stress the material can withstand (see table below). With reference to the former designations, both PEM and PEH pipes are available within the PE 63 and PE 80 groups. PEM pipes have a somewhat lower modulus of elasticity than PEH pipes and are therefore more flexible. PE 100 pipes are always PEH. The difference in short-term stress between the various PE materials is not great (see figure on page 3).

17.2 PE pipes for various applications

Standardised PE pressure pipes

PE pressure pipes are manufactured with smooth walls in a range of outside diameters from 16 mm to 1600 mm. Pipes are available in standard pressure ratings, and usually comply with national and international standards. The following international standards exist:

- ISO 4427 Polyethylene (PE) pipes for water supply – Specifications (see references)
- prEN 12201 Plastics piping systems for water supply – Polyethylene (PE) (see references)

The proposed EN standard is expected to be adopted in 2002, after which the various national standards in European countries will be adapted to comply with EN 12201.

As the design stress of various PE materials is not equal, the wall thickness of PE pipes also differs. PE pipes are normally manufactured in several standard classes, so-called SDR classes (see table overleaf), where the SDR number is the relationship between the outside diameter of the pipe and its wall thickness.

Pipe pressure rating is determined partly by the material the pipe is made of (e.g. PE 80 or PE 100) and partly by the SDR class chosen. As different standards use different nominal pressures, one and the same pipe can be rated differently. The table on page 3 shows the relationship between nominal pressure rating (PN), PE material and SDR class according to prEN 12201. The nominal pressure rating gives the maximum permissible operating pressure in the pipeline at +20°C. The permissible pressure at higher temperatures must be reduced as stipulated in ISO 4427 and prEN 12201.

Material classification of PE pipes.

Designation	Long-term stress (MPa)	Design stress (MPa)
PE 63	6.30 - 7.99	5.0
PE 80	8.00 - 9.99	6.3 *
PE 100	10.00 - 11.99	8.0

* According to current Danish, Norwegian and Swedish standards, the design stress for PE80 pipes is 5.0 MPa.

PE PIPES FOR THE NO-DIG SECTOR

In current Danish, Norwegian and Swedish standards, the design stress is 5.0 MPa for PE 80 pipes. This means that these pipes receive the same pressure rating as the PE 63 pipes in the table on the following page.

Standardised PE pressure pipes can, of course, also be used for lining gravity pipelines. If so, a suitable SDR class should be chosen on the basis of the stiffness required – see also section 17.3.

Standard SDR classes according to prEN12201-2.

Nominal wall thickness (mm)											
DN/OD	SDR 6	SDR 7,4	SDR 9	SDR 11	SDR 13,6	SDR 17	SDR 17,6	SDR 21	SDR 26	SDR 33	SDR 41
16	3.0	2.3	2.0								
20	3.4	3.0	2.3	2.0							
25	4.2	3.5	3.0	2.3	2.0						
32	5.4	4.4	3.6	3.0	2.4	2.0	2.0				
40	6.7	5.5	4.5	3.7	3.0	2.4	2.3	2.0			
50	8.3	6.9	5.6	4.6	3.7	3.0	2.9	2.4	2.0		
63	10.5	8.6	7.1	5.8	4.7	3.8	3.6	3.0	2.5		
75	12.5	10.3	8.4	6.8	5.6	4.5	4.3	3.6	2.9		
90	15.0	12.3	10.1	8.2	6.7	5.4	5.1	4.3	3.5		
110	18.3	15.1	12.3	10.0	8.1	6.6	6.3	5.3	4.2		
125	20.8	17.1	14.0	11.4	9.2	7.4	7.1	6.0	4.8		
140	23.3	19.2	15.7	12.7	10.3	8.3	8.0	6.7	5.4		
160	26.6	21.9	17.9	14.6	11.8	9.5	9.1	7.7	6.2		
180	29.9	24.6	20.1	16.4	13.3	10.7	10.2	8.6	6.9		
200	33.2	27.4	22.4	18.2	14.7	11.9	11.4	9.6	7.7		
225	37.4	30.8	25.2	20.5	16.6	13.4	12.8	10.8	8.6		
250	41.5	34.2	27.9	22.7	18.4	14.8	14.2	11.9	9.6		
280	46.5	38.3	31.3	25.4	20.6	16.6	15.9	13.4	10.7		
315	52.3	43.1	35.2	28.6	23.2	18.7	17.9	15.0	12.1	9.7	7.7
355	59.0	48.5	39.7	32.2	26.1	21.1	20.1	16.9	13.6	10.9	8.7
400		54.7	44.7	36.3	29.4	23.7	22.7	19.1	15.3	12.3	9.8
450		61.5	50.3	40.9	33.1	26.7	25.5	21.5	17.2	13.8	11.0
500			55.8	45.4	36.8	29.7	28.3	23.9	19.1	15.3	12.3
560				50.8	41.2	33.2	31.7	26.7	21.4	17.2	13.7
630				57.2	46.3	37.4	35.7	30.0	24.1	19.3	15.4
710					52.2	42.1	40.2	33.9	27.2	21.8	17.4
800					58.8	47.4	45.3	38.1	30.6	24.5	19.6
900						53.3	51.0	42.9	34.4	27.6	22.0
1000						59.3	56.6	47.7	38.2	30.6	24.5
1200								57.2	45.9	36.7	29.4
1400									53.5	42.9	34.3
1600									61.2	49.0	39.2

Nominal pressure rating PN (bar)										
PE material	SDR 41	SDR 33	SDR 26	SDR 21	SDR 17	SDR 13,6	SDR 11	SDR 9	SDR 7,5	SDR 6
PE100	4	5	6.3	8	10	12.5	16	20	25	32
PE80	3.2	4	5	6.3	8	10	12.5	16	20	25
PE63	2.5	3.2	4	5	6.3	8	10	12.5	16	20

Nominal pressure rating for standardised PE pipes of various materials according to prEN 12201.

PE pipes produced to meet manufacturer's standards

Several manufacturers of PE pipes also have various types of ribbed pipes in their product range. These pipes are designed for use in non-pressure pipelines and are joined in various ways. Generally, there is a lack of standards for ribbed pipes. Product properties are therefore stated by the manufacturers.

Some pipe manufacturers even produce so-called short pipes with smooth surfaces for lining purposes. The pipes have specially designed joints, whose properties can be obtained from the manufacturer. Some joint types are capable of absorbing axial forces to some degree.



17.3 Design criteria for PE pipes

A buried pipe is subjected to loads internally from pressure within the pipe and externally from the surrounding ground, traffic and groundwater. A pipe laid directly in the ground is supported by the surrounding backfill material. For buried pressure pipes, the effect of the internal pressure is therefore often much greater than the effect of external loads. It is thus to a large extent the internal water pressure that determines which SDR class is required.

When PE pipes are used for NO-DIG installations, it is not certain that they are as well supported as when they are buried in the conventional way. In this case, it is therefore necessary to take the ability of the pipes to withstand external loads into account.

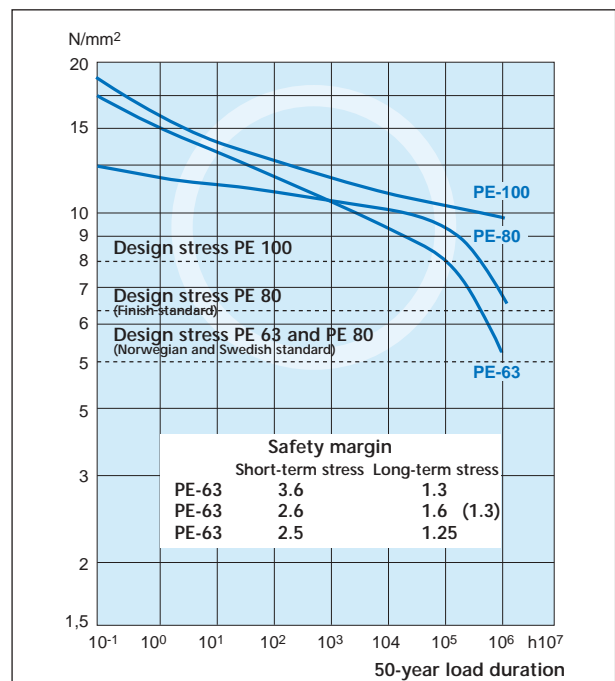

SDR class	Ring stiffness* (kN/m ²)
41	1.25
33	2.5
26	5
21	10
17	19
13.6	38
11	75
9	150
7.5	275
6	600

* Calculated ring stiffness for PE material with a modulus modulus of elasticity of 900 MPa (PE 80 pipes of PEH type). The stiffness of PEM pipes is about 10% lower, while that of PE 100 pipes is about 10% higher.



This depends on the ring stiffness of the pipe, as determined by the following formula:

■ $S = EI/D^3$
 where S = pipe ring stiffness (N/m²)
 E = pipe modulus of elasticity (N/m²)
 I = pipe wall moment of inertia (m³)
 D = mean pipe diameter (m)

For pipes with homogeneous, smooth walls, this formula can be rewritten as:

$$S = \frac{E}{12} \left(\frac{s}{D}\right)^3$$

where s = pipe wall thickness (m).

The above table shows ring stiffness for PE pipes with a modulus of elasticity of 900 MPa (3 min., +20°C).

The choice of SDR class depends on the operating conditions the new pipeline is to be designed for and the loads the pipe will be subjected to during installation. The SDR classes normally used for various NO-DIG methods are shown in section 17.6.

17.4 Methods of joining PE pipes

Standardised PE pipes are normally joined by butt fusion or electrofusion.

Butt fusion

The most common method for joining PE pipes is butt fusion. A small welding bead is formed on the inside and outside surfaces of each butt-fused joint (see photo above). Usually, these beads are left in place to avoid weakening the joint. The internal welding bead normally has negligible effect on friction within the pipeline. If a high degree of internal or external smoothness is required, welding beads can be cut away just after welding while the material is still relatively soft.

Alternative joining methods

As an alternative to butt fusion, standard smooth-walled PE pipes can be joined using electrofusion.

Ribbed PE pipes are joined using various methods. Individual manufacturers should be contacted for further details.

17.5 Control of PE pipes

Control of pipe products

The majority of PE pipes have some kind of approval or quality marking. In the Nordic countries, standardised PE pipes can be marked DS, NS, SFS or SIS depending on to which national standard the product is certified. Marking entails that the products are subjected to process control systems in which data are collected and stored at the manufacturer's, and that the products are regularly tested by an independent testing institute.

Country	Leak testing standard for PE pressure pipelines	Leak testing standard for PE non-pressure pipelines
Denmark	DS 2119	DS 455
Finland	SFS 3115	SFS 3113, SFS 3114
Norway	NS 3551	NS 3550, NS3551
Sweden	VAV P78	VAV P50, SPF-report 01

In Sweden, KP marking is used for non-standardised products. The marking entails that the products are checked in the same way as standardised products, i.e. in accordance with specified requirements approved by KP, the Swedish Board of Control for Plastic Pipes (Kontrollrådet för plaströr).

Leak testing after installation

Leak testing is usually performed after installation to check that all joints are tight. The above table shows the leak testing standards normally used in the Nordic countries.

In connection with leak testing of pressure pipelines installed using NO-DIG techniques, it should be noted that PE pipes are better able to expand when inserted in existing pipelines and have no side support than when they are buried in the ground. It is therefore important that the pipeline

be pressurised for a sufficient length of time before the test is performed in order allow the pipe to expand as much as possible before starting the test. Otherwise, the test result may be misleading – pipe expansion may be interpreted as leakage.

17.6 PE piping normally used for NO-DIG techniques

The NO-DIG methods in which PE pipes are most commonly used are:

- Conventional sliplining
- Lining with short PE pipes
- Close-fit lining
- PE pipeline installation using directional drilling

The table below shows the types of PE pipe commonly used for the various NO-DIG techniques.

NO-DIG technique	PE pipe type usually used
Conventional sliplining of pressure pipelines	PE 80 or PE 100 pipes of SDR 17 or lower
Conventional sliplining of gravity pipelines	PE 80 pipes of SDR 17 or lower
Lining with short pipes	PE 80 pipes of SDR 17 or lower
Close-fit lining	PE 80 or PE 100 pipes of SDR 17-33. (the larger the pipe diameter, the higher the SDR class should be - for very large lines, pipes of SDR class 41 or higher can even be used)
Directional drilling	PE 80 or PE 100 pipes of SDR class 17 or lower



18 Standardisation in the field of pipeline rehabilitation

18.1 Introduction

What is standardisation?

Standardisation is an organised decision-making process with the purpose of preparing uniform guidelines for, among other things, the function and reliability of products and formulating common specifications, procedures and terminology.

In order to gain acceptance among users, standards must be based on the broadest possible agreement. This is assured via the basic principles that apply to all standardisation. Briefly, this means that standards must be developed in an open and transparent consensus process in which the opinions of all interested parties are heard.

What is a standard?

A standard is a document whose content represents a technical compromise reached by way of a decision-making process based on consensus, i.e. there is general agreement about a standard in the committee preparing it without the agreement necessarily being unanimous.

Fundamentally, there are seven different types of standards (see figure below). However, in practice, most standards are a mixture of several types. A standard may, for example, set requirements for design (paper format, data formats, dimensions/size of components), systems (quality assurance, environmental management or a sewer piping system) or performance (load and reliability, insulation capacity, lighting, material properties).

Standards may also describe the terminology of a field or describe methods for chemical analysis, testing, etc. Standardisation is especially concerned with performance so as to avoid limiting innovation and development.

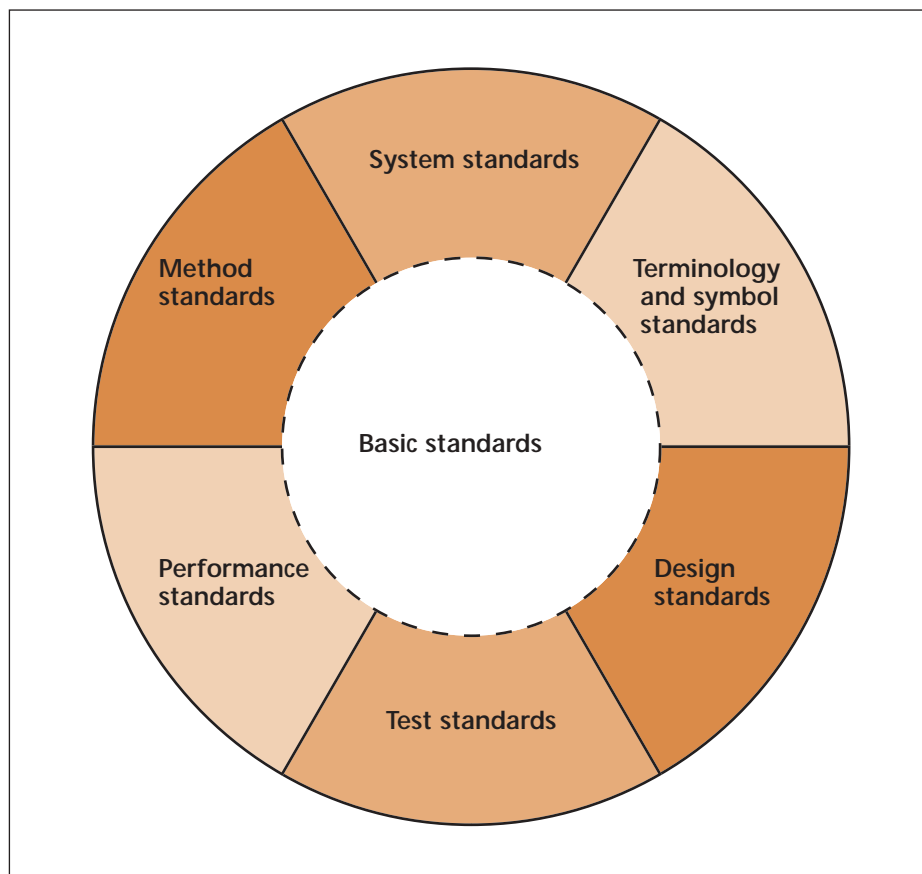

There are seven fundamental types of standard.

Is the use of standards obligatory?

Basically, whether a specific standard is followed or not is voluntary. A standard is merely a proposal for users. National, international and European standards institutions have no authority to make the use of standards compulsory.

However, in some cases, companies have an obligation to comply with standards. For example, when a company claims that its product or service meets the requirements of a certain standard in its marketing of the product or service.

Similarly, a company has a legal obligation if it claims in a contract or marking scheme that its product or service complies with one or more standards.

Finally, authorities may make standards compulsory if legislation stipulates that specific standards be met. Similarly, by referring to specific standards, the product liability directive and the directives on public tendering make it compulsory to comply with these standards.

18.2 Nordic, European and international standardisation

Standardisation work is performed on four levels: national (Danish, Swedish and Norwegian), Nordic, European and international. European and international standardisation work predominates. Nordic co-operation on standardisation has gradually receded into the background in step with the development of European and international standards.

National standards

DS (Dansk Standard) is the Danish standards institution that prepares Danish standards and norms. A special terminology is used in Danish standardisation as a distinction is made between norms and standards.

A norm is a general document that stipulates overriding demands or function requirements for, for example, a sewer system, and provides instructions for ways in which these basic requirements can be met when, for example, sewer systems are planned and designed.

A standard is a product-orientated document that stipulates in detail the requirements that specific products must meet. For example, this could be a product standard for plastic or concrete pipes stipulating requirements on dimensions, tolerances, strength, durability, etc.

ISO

ISO (International Organization for Standardization) is a worldwide association of national standards institutions in which more than 100 countries participate. For many years, ISO has prepared test standards for materials and components. Countries are under no obligation to adopt ISO standards as national standards.

CEN

CEN (Comité Européen de Normalisation) is the European standards institution whose purpose is to prepare common European standards for products and materials in order that products complying with an approved CEN standard can be freely exported to other European countries (the single European market). CEN members constitute the standards institutions in EU and EFTA countries and the Czech Republic.

18.3 CEN structure

The work involved in preparing European standards is performed in CEN technical committees. There are three relevant technical committees with regard to water and sewer pipelines:

- TC 155 Plastic piping systems and ducting systems
- TC 165 Waste water engineering
- TC 164 Water supply

The work of preparing standards is performed in working groups (WG), and each of the technical committees appoints a number of working groups responsible for specific fields or topics. As some of the working groups have responsibility for broad areas, task groups (TG) are often appointed to perform preparatory work on the various standards.

18.4 Standards for pipeline renovation

Work with preparing standards for pipeline renovation was commenced in 1988 by the international standards organisation, ISO. In 1992, ISO and CEN agreed that the standardisation of pipeline renovation should continue within the framework of CEN on the basis of the recently published ISO document "Technical Report, ISO/TR 11295, First edition 1992-08-01.

Techniques for rehabilitation of pipeline systems by the use of plastics pipes and fittings" (see references).

As this report covered renovation techniques using plastic materials, it was only natural that the preparation of standards for pipeline renovation was started in TC 155, the committee working with plastic piping and ducting systems.

TC 155 Plastic piping systems and ducting systems

It was TC 155 that started work in the area of pipeline renovation, and it is primarily system standards that have been prepared.

The table below shows an overview of the standards for pipeline renovation that TC 155 is preparing. Approved CEN standards are designated EN xxx, while standards yet to be approved are designated prEN xxx. If a subject is unnumbered, it is still being discussed in the technical committee, a working group or task group.

- Stage 32: Draft documents sent to TC
- Stage 40: Standard ready for preliminary review/vote in CEN
- Stage 49: Standard ready for final vote (approval)

Overview of standards on pipeline renovation under preparation by TC 155.

No.	Title	Stage	Date
prEN 13566-1	Plastics piping systems for renovation of underground non-pressure drainage and sewerage networks – Part 1: General	CEN Stage 49	6/2001
prEN 13566-2	Plastics piping systems for renovation of underground non-pressure drainage and sewerage networks – Part 2: Lining with continuous pipes	CEN Stage 40	6/2001
prEN 13566-3	Plastics piping systems for renovation of underground non-pressure drainage and sewerage networks – Part 3: Lining with close-fit pipes	CEN Stage 49	6/2001
prEN 13566-4	Plastics piping systems for renovation of underground non-pressure drainage and sewerage networks – Part 4: Lining with cured-in-place pipes	CEN Stage 49	6/2001
prEN 13566-7	Plastics piping systems for renovation of underground non-pressure drainage and sewerage networks – Part 7: Lining with spirally-wound pipes	CEN Stage 32	8/2001
	Plastics piping systems for renovation of underground water supply networks – Part 1: General	CEN Stage 40	6/2001
	Plastics piping systems for renovation of underground water supply networks – Part 3: Lining with close-fit pipes	CEN Stage 40	6/2001
	Plastics piping systems for renovation of underground gas supply networks – Part 1: General	CEN Stage 40	6/2001
	Plastics piping systems for renovation of underground gas supply networks – Part 3: Lining with close-fit pipes	CEN Stage 40	6/2001
prEN 13689	Guidance on the classification and design of plastics piping systems used for renovation	CEN Stage 49	6/2001

No.	Title	Stage	Date
EN 13380	General requirements for components used for renovation and repair of drain and sewer systems outside buildings General requirements for components used in trenchless construction of drains and sewers	issued	1998
EN 295-7	Vitrified clay pipes and fittings and pipe joints for drains and sewers – Part 7: Requirements for vitrified clay pipes and joints for pipe jacking	issued	1995
EN 12889	Trenchless construction and testing of drains and sewers	issued	2000
EN 752-5	Drain and sewer systems outside buildings – Part 5: Rehabilitation	issued	1997
prEN 13508-1	Condition of drain and sewer systems outside buildings – Part 1: General requirements for evaluation	CEN Stage 32	6/2001
prEN 13508-2	Condition of drain and sewer systems outside buildings - Part 2: Visual inspection coding system	CEN Stage 40	6/2001
	Management and control of cleaning operations in drains and sewers	CEN Stage 32	6/2001

Overview of standards on pipeline renovation and related areas under preparation by TC 165.

TC 165 Waste water engineering

TC 165, which works with drain and sewer systems inside and outside property boundaries, has also begun work on pipeline renovation. Here, the standards are of more general nature and can often be compared with instructions and directions for, for example, renovation planning, CCTV inspection or operation and maintenance of sewer systems.

The above table shows an overview of the standards TC165 is working on in the field of pipeline renovation.

TC 164 Water supply

TC 164, which works with water supply, does not currently have working groups on subjects related to pipeline renovation.

18.5 Implementation of CEN standards

All national standards institutions are committed to CEN. Within six months of CEN approving a standard, national standards institutions have an obligation to implement (issue) the standard while national standards dealing with the same subject must be withdrawn. The only exception to this rule is when a national standard is named in an act or is part of legislation. In this case, the legislature alone decides whether the CEN standard is such of a quality that it can become part of the legislation.

Even though a standard has been issued by a national standards institution, there is no general requirement that it must be used, and some of the issued standards are not translated into Danish if no one shows an interest in their use. The only exception is, as previously mentioned, the directives on public tendering used when projects are large enough to require EU tendering. In such tendering, it is a requirement that any CEN standards on the area in question be referred to in tenders, and thus form the contractual basis between the parties concerned.

18.6 CE marking

In future, product standards, which stipulate requirements for the design and function of a product, will become "compulsory" because they form the basis of CE marking.

All construction materials covered by a harmonised standard or European technical approval (ETA) must be CE marked before they are sold or marketed on the single European market.

CE marking may only be used for construction materials covered by a harmonised standard or ETA. These regulations also apply to construction materials manufactured solely for domestic markets.

The CE mark is the only compulsory harmonisation certification that may be used on the single European market, and it therefore replaces any compulsory national harmonisation certification.

CE marked construction materials must not be subjected to national requirements for new tests or approvals, but may be freely sold in all countries in the single European market.

CE marking gives no information on quality. It is therefore possible to supplement the CE mark with various voluntary marks. Manufacturers may thus choose to join a voluntary certification programme that entails a higher level of compliance attestation than is stipulated in the harmonised standard or ETA.

It is not yet known whether system standards prepared on pipeline rehabilitation systems will provide a basis for CE marking.

In Denmark, there are three control schemes concerned with the investigation and rehabilitation of sewer systems. This chapter will describe these schemes, including their scope, function and the areas covered. The benefits gained by municipal authorities from the schemes will also be discussed.

19.1 Why are control schemes important?

At present, millions of Danish kroner are invested each year in investigating and improving the Danish sewer system. By all accounts, the real need for investment is actually far greater than current levels. The sewer system is worn out in many places, and therefore the need to rehabilitate large parts of the system is urgent. As the work must be performed quickly, it is important to assure the quality of both the preliminary surveying and the renovation work itself. For when the actual rehabilitation needs are held up against the available budgets, it becomes clear that the renovated sewer system must remain operative without further renovation and renewal for at least the next 100 years. It is also important to ensure that funds are invested wisely so that the best solutions in specific situations are chosen the first time round.

Three control schemes have been established in Denmark to assure the quality of preliminary surveying and certain renovation techniques:

- Control Scheme for Danish CCTV Inspection Companies (Danske TV-inspektionsfirmaers kontrolordning)
- Control Scheme for Pipeline Rehabilitation (Kontrolordning for ledningsrenovering)
- Control Scheme for Directional Drilling and Pipe Jacking (Kontrolordning for styret boring og gennempresning)

In Norway and Sweden, the sector has chosen not to establish control schemes.

The value of control schemes has been discussed in Sweden, but the need for external control was deemed unnecessary in light of the fact that suppliers have already systematically described their work with quality, the general environment and the work environment in, for example, the documentation provided for product certification. In addition, customer requirements are taken into account in tendering documents and hand-over procedures.

In Norway, the authorities must be notified of all renovation work except minor repair. In future, work must be checked in compliance with re-

gulations stipulated in the new planning and building Act. These regulations distinguish between self control, peer control and third party control.

The control method to be used for specific projects is decided upon by the relevant building authority in connection with its consideration and approval of the project. No permanent, approved scheme is presently found in Norway, where all responsibility is placed on the parties planning and performing the work. These parties prepare control forms and checklists that are submitted to the building authority for consideration in connection with its approval of the project.



The logo of the Control Scheme for Danish CCTV Inspection Companies (DTVK).

The three Danish schemes are described in the following.

19.2 Control Scheme for Danish CCTV Inspection Companies (DTVK)

Control Scheme for Danish CCTV Inspection Companies (DTVK) is the oldest of the Danish control schemes. It was established in 1986 at the request of the municipal authorities who did not have the capacity to perform the necessary thorough control of the many videotapes of closed circuit television (CCTV) inspections from sewer condition surveys.

Prior to this, the largest municipal authorities had begun collaborating with several specialists in 1985 on systematising observations from sewer inspections with CCTV. This work resulted in the preparation of a photo manual, the 4th edition of which was published in December 1997 (see references). All CCTV inspections carried out under DTVK are presently based on this photo manual. The photo manual can be ordered by contacting DANAS, the Danish Water and Waste Water Association (Dansk Afløbs- og Spildevandsforening).

Collaboration on the photo manual also resulted in the publication of the report CCTV Inspection of Sewer Lines – Appendix to AB92 and Description of Procedures (TV-inspektioner af afløbsledninger – Tillæg til AB92 og beskrivelser til udførelse) (see references). This report, the

3rd edition of which was published in 1995, was written to ensure the quality of tendering documents in connection with large CCTV inspection contracts. The report is designed as an appendix to AB92 and also contains a paradigm for procedural descriptions of how the flushing and/or CCTV inspection of sewer pipelines and the associated reporting should be performed. The report can be ordered from the Danish Technological Institute.

Both the above-mentioned reports are currently used by almost everyone who invites tenders for large CCTV inspection contracts.

While it is one thing to ensure that the conditions for a successful CCTV inspection are in order, both contractually and with respect to reporting procedures, it is quite another to ensure that CCTV operators actually comply with the current standard definitions contained in the photo manual when reporting. DTVK was established in recognition of the fact that not all pipeline owners have the capacity to assess whether this is achieved.

DTVK is managed by an independent control committee with representatives from the Danish Association of Local Authority Technical Directors (Kommunalteknisk Chefforening), the Danish Association of Consulting Engineers, the Danish Technological Institute and the CCTV inspection group under the Danish Contractors' Association.

Committee members are appointed for a two-year term and can be re-appointed.

Membership of the scheme is voluntary, but most CCTV inspection companies have joined in recognition of the fact that pipeline owners

usually require that CCTV inspections be performed in compliance with the scheme. In October 2001, there were 27 companies in the scheme. A list of DTVK member companies is published twice yearly in the magazine Stads- og Havneingeniøren.

19.3 The purpose of DTVK

The purpose of the scheme is to ensure that CCTV inspection complies with the quality requirements stated in the photo manual and in DTVK's technical regulations. These technical regulations ensure that besides requirements for reporting, requirements for the organisation, personnel, training, equipment and self control of member companies are also followed up.

Among the steps taken by DTVK to ensure this are inspection visits and regular spot checking of the periodic reports submitted in compliance with the principles described in DS 2184. This spot-checking is performed for DTVK by two technical consultants.

Spot checking specifically targets the work of individual CCTV operators in member companies who must regularly submit lists of the work performed by individual operators. From these lists, the technical consultants select at random a number of pipeline runs which are then checked to make sure that reports submitted have been prepared correctly. Spot checking is organised so that new operators, operators who seldom carry out inspections, and operators who repeatedly make errors are checked more often than experienced, full-time operators who make few – often arbitrary – errors.

DTVK also ensures that CCTV operators are trained and constantly receive supplementary training. After initial training, operators must pass a practical test in order to qualify for a certificate, which unless stated otherwise remains valid for one year. If spot checking reveals that an operator's work is sub-standard, his/her certification can be revoked, and the operator required to re-sit the test before again being permitted to perform CCTV inspection under DTVK.

CCTV operators must translate what they see on screen to an observation in a report. This is not an easy task, as it can be difficult to express a complicated picture using two letters and a number. However, this is precisely where the strength of the DTVK control scheme lies as the two highly experienced technical consultants are able to check more than 200 km of the 3000 km that are inspected annually in Denmark using CCTV.

The control committee inspects work site layout.



The scheme also entails that those who have invited tenders for a CCTV inspection under DTVK and have awarded the contract to a member company may lodge complaints with or submit enquiries to DTVK.

The Danish municipal authorities recognise the need for high-quality CCTV inspections that do not contain serious reporting errors – errors which may result in a wrong decision to renovate a section of pipeline that is not yet in need of repair. That is why CCTV inspection under the auspices of DTVK has been more or less a standard in tendering requirements for many years.

Hopefully, it is obvious from the above-mentioned benefits that all pipeline owners should continue to demand that companies tendering for extensive CCTV inspection contracts be covered by the control scheme. This is the only way of ensuring that the work is of uniform quality and has been performed in accordance with well-established procedures by well-trained operators with up-to-date knowledge of the methods used.

19.4 Control Scheme for Pipeline Rehabilitation

The Control Scheme for Pipeline Rehabilitation was established in 1996 as a consequence of the fact that trenchless rehabilitation methods require a different type of quality assurance than conventional trenching. In conventional open-cut renovation, factory-made components (which can be checked and tested before installation) are used. In trenchless renovation, the product is established on-site, and installation techniques are therefore of great importance. In recognition of this fact, a control scheme for pipeline rehabilitation, the first of its kind, was established in Denmark.

The control scheme is managed by an independent control committee with representatives from Danish Water and Waste Water Association, the Association of Local Authority Technical Directors and the Danish Association of Consulting Engineers. Further information is available at www.nodig-kontrol.dk.

The logo of the Control Scheme for Pipeline Rehabilitation.



Committee members are appointed for a three-year term, and may be re-appointed once. When considering company-related matters, the committee can call in two representatives from member companies to form what is known as the extended control committee.

Membership of the scheme is voluntary, but this control scheme too has won so much respect that all the largest NO-DIG contractors have joined – not least because pipeline owners often demand that work be performed in compliance with the scheme.

The control scheme only covers the renovation of gravity sewer lines and currently includes cured-in-place lining and pipe bursting. In late 2001, five cured-in-place lining systems from five different companies were included in the control scheme.

19.5 The purpose of the Control Scheme for Pipeline Rehabilitation

The Control Scheme for Pipeline Rehabilitation ensures that contracts performed by member companies using systems included in the control scheme are carried out in accordance with an approved method declaration for the system in question.

This method declaration is prepared by the member company and contains in addition to a description of the method the following information:

- Material properties
- Product properties
- System properties
- Applications/limitations

For cured-in-place lining systems, the method declaration must state which characteristic values the product must comply with for parameters like:

- Ring stiffness – modulus of elasticity (long-term and short-term values)
- Bending – tensile strength, rupture strain and modulus of elasticity (short-term values)
- Pulling – tensile strength, rupture strain and modulus of elasticity (short-term values)

The values must be documented results of experiments carried out at an accredited laboratory on a product made on the member company's own installation equipment.

In the case of pipe bursting, documentation must be provided to confirm that the pipe mate-

rial is supplied by a manufacturer who uses an approved control system.

Demands are also made in respect of the member company's own quality assurance and the preparation of control plans for the work to be performed.

Such control is ensured through companies being paid unannounced inspection visits at least once a year, in order that production plant, test results, quality assurance measures and control measures can be inspected. These visits are carried out by the control committee together with one of the affiliated technical consultants.

The control includes inspection visits to the company itself and its sites in order to ensure that the quality assurance system is being observed in both places.

In the case of cured-in-place lining, the control scheme requires that samples be taken from at least 25% of the total number of installations within a given period. Depending on control class, the company itself tests at least 10 or 25% of the total number of installations and reports the results in six-monthly process-control reports. The control committee comments on these reports. During its inspection visit, the control committee also selects a random sample for testing. The sample is subsequently tested at an accredited laboratory, and the results obtained are compared with the declared values.

Under the control scheme, design guidelines for cured-in-place lining and pipe bursting have been prepared in order to ensure that calculations are made on a uniform and approved basis. Member companies are committed to using these design guidelines, and documentation of their use must be presented to the control committee during inspection visits. The design guidelines were revised in 2002.

If the control committee discovers that a method does not meet the requirements of the method declaration, the control and inspection of the method in question will be intensified. The committee may also decide to exclude the member company from the control scheme.

The scheme also entails that complaints about the control scheme or about matters concerning the approved method declarations of member companies may be brought before the control committee. On the basis of such complaints (or for other reasons), the control committee may decide to perform supplementary inspection visits, to intensify the process control or to exclude the member company.

No paradigm for inviting tenders in the field of sewer line renovation has been prepared under the control scheme. Material for use when inviting tenders has, however, been prepared by the Danish Technological Institute in collaboration with several municipal technical departments, municipal companies and the NO-DIG group under the Danish Contractors' Association. The tendering paradigm (see references) is available from the Pipe Centre at the Danish Technological Institute.

In the field of pipeline rehabilitation, Danish municipal authorities have recognised the need for a product that complies with several critical preconditions, all of which are described in the method declarations for specific techniques. Also in this respect, cured-in-place linings installed in compliance with the control scheme have therefore almost become standard in municipal authority tendering terms in recent years.

All pipeline owners planning renovation using the methods discussed here should be urged to continue insisting that the systems used by all contractors offering tenders be included the control scheme. This is the only way to ensure that work is performed in accordance with well-known and declared methods, and that contractors offering tenders have used uniform design guidelines.

19.6 Control Scheme for Directional Drilling and Pipe Jacking

The third control scheme is the Control Scheme for Directional Drilling and Pipe Jacking. It is the newest of the three schemes, and was established at a general meeting on 13 March 2001.

This control scheme was formed because Kontrolordning for ledningsrenovering does not cover directional drilling techniques or soil-displacing pipe jacking. These trenchless installation methods have seen explosive development in recent years, and long pipeline runs can now be installed within narrow tolerances. The methods have thus become attractive alternatives to trenching, and are increasingly used in both the private and municipal sectors.

A desire to have the techniques placed under an independent quality control scheme has arisen in the wake of these advances.

The control scheme is managed by an independent control committee with representatives from DANAS, the Joint Committee on Pipeline Cooperation (FULS) (Fællesudvalget vedr. Ledningssamarbejde), and the Danish Association

of Consulting Engineers. Further information is available at www.nodig-kontrol.dk.

Committee members are appointed for a two-year term, and may be re-appointed twice.

As with the Control Scheme for Pipeline Rehabilitation, the control committee of this scheme can also call in member company representatives to an extended committee when evaluating company-specific matters. During the start-up phase, it has been decided that there should be four company representatives on the extended committee. This is a natural consequence of the fact that the working group, which prepared the statutes and technical regulations for the control scheme, consisted of the same four persons.

In common with the other schemes, membership of this one is voluntary, but contractors have shown so much interest that the inclusion of many directional drilling and pipe jacking techniques seems likely in the future.

The control scheme covers all trenchless methods of establishing pipelines. The methods can be roughly divided into two categories: non-steerable earth-displacing or earth-moving methods and steerable methods such as microtunnelling, pilot boring and directional drilling. Common to all methods is that the work performed underground is remote controlled by personnel on the surface. The methods are therefore "unmanned" in contrast to "manned" or "manual" methods such as minitunnelling in which personnel work in the drill pipe itself during installation.

19.7 The purpose of the Control Scheme for Directional Drilling and Pipe Jacking

The Control Scheme for Directional Drilling and Pipe Jacking has the same purpose as the Control Scheme for Pipeline Rehabilitation, i.e. to ensure that contracts in which methods included in the control scheme are used, are performed in compliance with an approved method declaration for the technique in question. The method declaration contains the following information:

- Method description
- Product description
- System properties (safety distances and tolerances)
- Applications/limitations

Documentation must confirm that piping comes from a company using an approved control system, and that the design of pipes and pipelines



The control committee also inspects technical conditions, e.g. launch pit design.

is in accordance with accepted common guidelines.

Additionally, demands are made on the quality assurance of member companies and on their preparation of control plans, specifications, drilling plans and drilling logbooks in connection with the work.

To ensure that member companies are observing the rules, they are paid at least one unannounced inspection visit annually. Production plant and logbooks of work performed are checked on these visits. Both the company itself and its sites are visited in order to ensure that the quality assurance system is being complied with both places.

The possibilities of lodging complaints and imposing sanctions are the same as described for the Control Scheme for Pipeline Rehabilitation.

The control scheme is still relatively new, but much effort is being devoted to preparing uniform design criteria and admitting the first companies to the scheme.

The control scheme encourages private and public pipeline owners planning the installation of new lines by means of the techniques described in this section to demand that the methods used be covered by the scheme. This is the only way to ensure that work is performed in accordance with well-known and declared methods, and that contractors have used uniform design guidelines.



Checking the company's quality assurance system.

19.8 Do the control schemes only ensure that the control is in order?

After this discussion of the three existing Danish control schemes, it is natural to ask the question: Do the Danish control schemes ensure that the control is in order?

Naturally, the answer is yes, but the control schemes provide much more than that. The fact that member companies and their personnel do not know which CCTV inspection or installation will be selected for control means that each task they perform is a kind of exam. This naturally increases the respect shown for the job in hand under every contract. And only by increasing the respect for our work can we ensure that the overall objective of sewer renovation and installation – i.e. improving the quality of the system so that it can remain in constant use for the next 100 years – is achieved.

The Danish control schemes help to achieve this objective. They should be used whenever demands are made on the methodology of CCTV inspection, pipeline renovation or pipeline installation using directional drilling or pipe jacking.

NO-DIG methods for renovating and installing almost all types of pipeline systems have been available in Scandinavia for many years. The considerable market share the methods have already won clearly demonstrates that they are here to stay.

The sector is also undergoing rapid development. Existing processes are being optimised and new renovation and installation techniques developed at such a rate that the many documented facts and practical experience described in this handbook can only be viewed as a static snapshot of how the NO-DIG sector looked in 2002!

What does the future hold for trenchless technology? Nothing is more difficult than predicting the future. But a look to the past can give an inkling of what lies in store for the future. NO-DIG trends in recent decades and the rate at which they have developed can give us some idea of the direction and speed of future development.

20.1 Status of 40 years' development

In the '60s

the first tentative trials of pulling short lengths of pipe into existing pipelines were carried out. This renovation method became more common after the introduction of plastic pipes, and various techniques – so-called sliplining techniques – are used today in a great number of projects where a reduction in pipe diameter is beneficial.

In the '70s

pipe bursting saw the light of day. Equipment that displaces or shatters the existing pipeline was developed for use in situations where sliplining was unsuitable because of the reduction in pipe diameter inherent in the method. Initially, pipe bursting techniques concentrated on brittle pipe materials like concrete, clay, and asbestos, but development continued and now pipes of almost any material can be burst.

In the '80s

the first cured-in-place liners were introduced. In the mid-1970s, the local authority in London announced that it no longer would accept the many excavations that were a colossal inconvenience for traffic. This was the starting signal for cured-in-place lining, which became the most widely used renovation system throughout the world for many years to come. This was also the decade when great advances in closed circuit television inspection were made.

In the '90s

the development of the above-mentioned methods continued and new techniques were introduced. Many new products resulted from ongoing product development, and they supplemented existing trenchless renovation and installation techniques. The only real innovation was directional drilling – the first trenchless method for new pipeline installation. Its introduction marked the beginning of a new era, and the method has already achieved a prominent market position.

And now, on the threshold of a new decade, we must try to predict future development trends for NO-DIG applications and techniques. If we look to the past, the continued development of additional methods and the continued improvement and optimisation of existing methods can be expected. There will, however, also be more focus on work environment, documentation and process control, and these areas will in all probability become key factors in future NO-DIG projects.

We can be sure of one thing – also in the near future: contractors, consultants and pipeline owners will still use NO-DIG methods wherever they are deemed beneficial. It is therefore appropriate to let each of these three interested parties give their thoughts on the future of trenchless renovation and on what future installation methods will mean in their daily work.

20.2 A contractor's scenario

In Denmark, the march of progress will continue for techniques registered in the national control schemes. In Norway and Sweden, there are no control schemes at present, but almost all products used in these two countries are registered in the Danish scheme via Danish contractors. The Danish control schemes ought to be extended to include the other Nordic countries. In future, the control schemes will cover all NO-DIG methods, including renovation techniques for service lines and laterals, and techniques for localised repair.

There will be increased focus on the properties of new and renovated pipelines, in particular strength, tightness and resistance. Attention will also focus on the overall roughness of the pipeline system and thus on its hydraulic function. All methods will be based on a service life of 100 years.

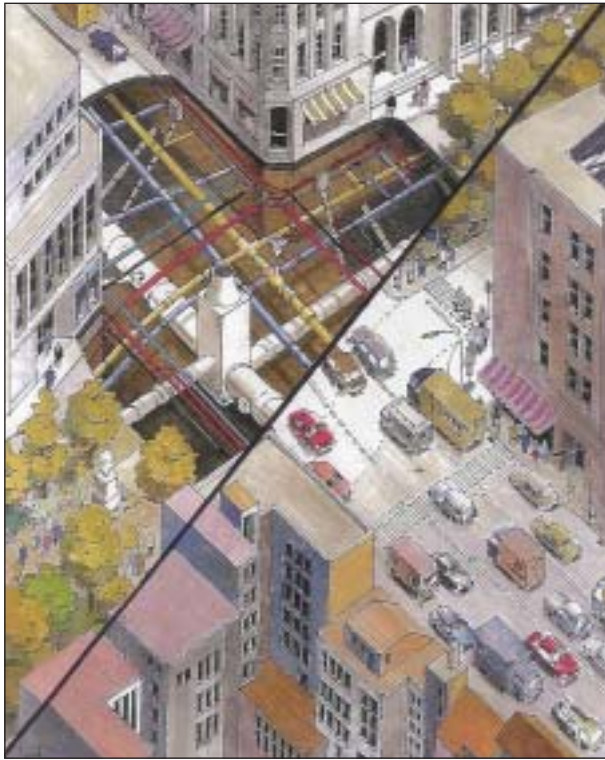

A complex network of pipelines is found under towns and cities.

Conditions for personnel and the work environment will be given top priority.

Society will expect unpolluted drinking water and the elimination of environmental problems. This in turn means that attention will focus on making sure that fluids transported in pipeline systems remain in their intended pipelines, in other words:

- Potable water in potable water pipelines
- Wastewater in wastewater pipelines
- Condensation in condensation pipelines
- Industrial fluids in industrial fluid pipelines
- Etc.

As a large proportion of pipeline defects discovered in previous years has been related to joints, future solutions will to a greater extent be based on long pipes with fewer joints. This will apply to conventional trenching techniques as well as NO-DIG methods. The need for renovation will increase in the future, as the techniques used for the past many years have to a large extent been based on short-pipe solutions, and have therefore included many joints.

Future tenders – especially with regard to municipal pipelines – will cover large areas, in many cases the total rehabilitation of entire neighbourhoods. Combined solutions – including both conventional trenching and trenchless technologi-

es – will become more common in rehabilitation projects and new installations. Larger contracts will allow optimisation of work processes and thus sharpen competitiveness. Industrial projects will become more numerous.

NO-DIG methods will contribute to a general improvement in the operation and maintenance of pipelines.

20.3 A consultant's scenario

How does the future of NO-DIG look from a consultant's point of view? The answer is uncertain, but it appears likely that NO-DIG will capture a larger market share than it has at present.

Pipeline owners and their consultants usually base the choice of renovation method on an overall assessment of technical, economic and environmental aspects.

From a technical viewpoint, attention is often focused on complete solutions, guaranteed tightness and strength, ability to prevent infiltration of water and pests, capacity problems and the risk of possible consequences, e.g. road collapse because of insufficient pipeline renovation. In some of these areas, conventional open-cut methods are still superior to newer NO-DIG techniques.

From an economic point of view, the service life of the pipeline system is an important factor. Over the entire service life of the pipeline, lower maintenance costs can be achieved by choosing quality solutions with service lives of 100 years or more. In addition, installation and operational costs are, of course, important. The capitalisation of social costs, a subject of discussion for many years, has seemingly had no effect on pipeline owners' choice of technique, and this situation is expected to remain the same in the future. Lower installation costs have been the prime argument in marketing NO-DIG methods. However, since connecting service lines and laterals is more expensive and since the savings achieved by the co-ordination of open-cut installation with the work of other pipeline owners, NO-DIG methods must continue development if they are to be a serious competitor to conventional trenching.

From an environmental point of view, investigations of which method is most beneficial are lacking. In this respect it is important not only to consider factors like ground water pollution and the use of fuel in factories (for the manufacture of products) or on site (resulting in localised pollution), but also to focus on issues concerning work environment, workplace layout, waste disposal and re-cycling.

At present, consultants suggest NO-DIG methods for lining sound, large concrete pipes that retain their load-carrying capacity. Here, the main purpose of lining is to stop infiltration through leaking joints. Good possibilities for future growth are expected in this field.

Consultants also see a future for NO-DIG methods in temporary repair work where pipeline owners can use a thin-walled cured-in-place liner or localised repair to prolong the service life of pipeline sections. By doing so, pipeline owners can defer the costs of re-laying or renovating pipelines to later budget periods, while funds presently available can be used on the backlog of truly worn-out pipeline sections.

In this respect, consultants and pipeline owners must realise that this is merely repair work designed to prolong the remaining service life of the pipeline. To achieve a service life of 100 years or more, it is necessary to establish a new pipeline or the existing line must be rehabilitated in such a way as to produce a new self-supporting pipeline.

If current developments continue, NO-DIG methods will be improved even more in coming years with respect to technical and economic aspects. In this light, there can be no doubt that in future, NO-DIG techniques will be pulled more frequently from consultants' toolboxes as strong alternatives to open-cut methods.

20.4 A pipeline owner's scenario

Through strengthened development and work process optimisation, NO-DIG techniques will become competitive with open-cut methods with respect to quality and price in all common situations. Aspects like social costs will become more deeply involved in decisions on choice of method, and will become topics for discussion in the 21st century.

NO-DIG techniques will develop into complete systems and solutions that cover all components of pipeline systems – main pipelines, service lines and laterals, manholes and any other types of related constructions.

High-quality NO-DIG solutions will be available, and, as a matter of course, all contractors covered by a control scheme will be able to document a minimum 100-year service life for their products.

Environmentally friendly products – assessed on complete cradle-to-grave analysis – will dominate future markets. Contractors supplying NO-DIG solutions will therefore, like all other companies, be met with demands for a documented environmental balance sheet, and this will be a determining factor in the choice of solution and method.

In future, pipeline owners will increasingly favour methods and solutions that require minimum operation and maintenance.

Space is required for open-cut work in city centres.



20.5 The future starts tomorrow

No one can say with certainty the extent to which each of these three scenarios describe truly the future for NO-DIG methods. If they are true, it must be concluded that NO-DIG methods will continue to be needed in the future. In any event, it has been established that NO-DIG techniques have proved to be good, robust, well-documented alternatives to trenching.

We believe that continued use of the techniques will gradually provide more experience that can lead to improved products – products with much greater strength, much improved tightness and much longer service life than those marketed today. In addition, work processes will become more efficient and prices will probably fall. Together, these factors will improve the competitiveness of NO-DIG methods so that to an even greater extent than at present they are able to compete with conventional open-cut methods.

Fundamental to whether the methods are used or not is knowledge of their existence. Providing such knowledge has been one of the objectives in preparing this handbook.

A	
Acceptable water loss	3■12
Acceptance criteria	4■14
B	
Bentonite	13■1, 14■4
Bore head	13■5
Butt fusion	17■4
Butt-fusion joining of a PE liner	9■4
C	
CAREW	3■2
CCTV	4■7, 4■11
CE marking	18■5
CEN (Comité Européen de Normalisation)	18■2
CEN standard	4■5, 4■15
Choice of method for the rehabilitation of service lines	4■10
Cleaned-out debris	7■4
Cleaning pig	7■4, 7■9
Cleaning sewer lines	7■1
Cleaning water lines	7■8
Cleaning with scraping tools	7■9
Close-fit lining	10■1
Close-fit methods	4■11
Collapsed pipelines	4■3
Compressed air inversion	8■6
Connecting laterals and branch lines	9■4
Control of PE pipes	17■4
Control Scheme for Directional Drilling and Pipe Jacking	19■4
Control Scheme for Pipeline Rehabilitation	19■3
Control schemes	19■1
Coordination with other pipeline owners and authorities	4■3
Cured-in-place lining	4■10, 8■1
Curing with UV light	8■6, 8■7
D	
Danish Act on Competitive Tendering	5■1
Danish Control Scheme for CCTV Inspection Companies (DTVK)	19■1
Declaration	19■3, 19■5
Decommission	15■1
Design criteria	3■6, 4■7, 8■5, 19■5
Design criteria and fuse-joining	12■4
Design criteria and fusion welding	9■2
Design criteria for PE pipes	17■3
Design guidelines	19■4
Directional Drilling	3■6, 13■1
Directors	2■1
Drawbacks for the surroundings	4■5
Drilling fluid	13■2, 13■4
Drilling mud	13■2
Drilling plans and drilling logbooks	19■5
Drilling rig	13■2
DS (Danish Standard)	18■2
Duration of rehabilitation work	4■5

E

Economic and timing aspects 4■4

Economic aspects 3■1, 3■3

Elasticity modulus 8■5

Electrofusion 12■6

Environmental aspects 4■2

Environmental aspects of CIPP products. 8■4

Environmental aspects of close-fit products 10■2

Environmental aspects of pipe bursting products 12■3

Environmental aspects of sliplining products 9■2

Environmental conditions
at the workplace 8■3, 9■2, 10■2, 11■3, 12■2, 13■2, 14■1

European technical approval (ETA) 18■5

Excavation of laterals 12■3

Exfiltration 4■9

F

False water loss 3■9

Fibreglass panels 11■2

Filling annular spaces with grout 9■3

Flushing equipment 7■4

Flushing head 7■5

Flushing hoses 7■5

Flushing vehicle 7■4

Foring med sammensvejste lange rør 12■2

G

Genuine water loss. 3■9

Gradient measurement 4■8

Grout injection 15■6

Grout injection 9■5

Guarantors 2■1

Gyroscopic devices 14■3

H

High-pressure flushing 7■3, 7■8

Homogeneous liners 8■1

Horizontal Directional Drilling 13■1

Hydraulic hammer 12■5

I

Impact moling 3■6

Incrustation 3■6

Infiltration 4■8

Informal tendering 5■2

Inject 11■5

Insidious leaks 3■8

Inspection methods 4■7

Installation 8■6

ISO (International Organization for Standardization) 18■2

ISTT 2■1

J

Jacking frame 14■3

L	
Langrørsforing	12■2
Laser technology	14■3
Launch and reception pit	13■2
Launch pit	12■4, 14■2
Leak detection	3■7
Leak testing	4■7, 17■5
Legislation	3■9
Limited tendering	5■2
Liner heating	10■4
Localised repair	4■4
Lubrication	14■4
M	
Manhole defects	15■3
Manhole inserts	15■5
Manhole renovation	15■1
Manhole renovation handbook	15■1
Manning coefficient	4■11
Measurement and registration of manholes	15■2
Micro tunnelling	14■1
MOUSE/SAMBA	4■2
N	
Non-homogeneous liners	8■1
Nordic annex	4■15
O	
Operational aspects	3■1
Overspill	4■8
Ownership (laterals)	4■6
P	
Panel design criteria	11■4
Panels and elements	15■5
PE pipes	17■1
PE pressure pipes	17■1
PEH pipes	17■1
PEL pipes	17■1
PEM pipes	17■1
Photo manual for cured-in-place pipelines	4■14
Photo manual	4■11
Physical condition	3■1
Pilot bore	13■3
Pipe bursting	4■11, 12■1, 12■2
Pipe bursting with an impact mole	12■5
Pipe bursting without an impact mole	12■1, 12■5
Pipe cracking	12■2
Pipe jacking	14■1
Pipeline accessibility	4■4
Pipeline function requirements	3■2
Planning service line rehabilitation	4■6
Planning sewer rehabilitation	4■1
Preliminary surveying	8■4

Private sewer system, the 4■5

Process control 19■4

Product life cycle assessment and environmentally friendly design 6■2

Profiles 11■1

Public tendering 5■1

Q

Quality assurance and documentation 8■8

R

Rational, systematic monitoring 3■11

Rats 4■8

Reamer 13■2, 13■4

Reception pit 12■5, 14■3

Regulations on laterals 4■5

Regulations on service lines 3■4

Rehabilitation method 4■3

Renovate 15■1

Ringstiffness 8■6

Root cutting 7■3

RTM technique 3■2

S

Saddle connectors 12■5

Safety and health 7■6

Safety measures 11■5

Service life 4■4

Service line on private property 3■4

Service lines/laterals 3■4

Sewer operational conditions 4■1

Sewer physical condition 4■1

Sewers 4■3

Shield for installing pipes 14■1

Sliplining 9■1

Smoke testing 4■7

Social costs 3■1, 3■3, 6■1

Soft foundations/subsidence 4■3

Soil displacement hammer 12■1

Spiral-wound sliplining 9■6

Spoil removal 14■2

Spoil removal in microtunnelling 14■3

Spray lining 15■6

SSTT 1■1

Standards for pipeline renovation 18■2

Steam curing 8■7

Steel pipe ramming 14■1

Steering 14■3

Survey of laterals 4■9

Swagelining 10■1

System separation 4■4

Systematic leak detection 3■13

T	
Technical aspects	3■2
Technical aspects	4■3
Tender fixing	5■2
Tendering in Denmark	5■1
Tracer testing	4■8
Tracking and guidance systems	13■5
Traditional method, the	15■5
Training	7■6
Trenchless installation and rehabilitation methods	1■1
Type of resin	8■1
U	
Unused laterals/service lines	4■9
W	
Walkover	13■5
Water inversion	8■6
Water loss	3■9
Water pipeline rehabilitation	3■1
Water pipelines	3■1
Welding beads	9■4
Working with high-pressure cleaning equipment	7■7
Z	
Zero-consumption method	3■11



ADVANCE

Distance excavated during a given time (shift or day).

ADVANCE PATH

Speed of advance of a pipe jack or other trenchless installation through the ground, generally expressed as either millimetres per minute or metres per day.

ANNULAR FILLER

Material for grouting the annular space between the existing pipeline and the lining system.

AUGER BORING

Method of forming a bore, usually from a drive pit, by means of a rotating cutting head. Spoil is removed back to the drive pit by helically wound auger flights rotating in a steel casing. The equipment may have limited steering capability.

AUGER TBM

Tunnel boring machine (TBM) in which the excavated soil is removed to the drive shaft by auger flights passing through the product pipeline pushed in behind the TBM.

BACK REAMER

Cutting head attached to the leading end of a drill string to enlarge the pilot bore during a pull-back operation to enable the product pipe to be installed.

BENT SUB

Offset section of drill stem close behind the drill head that allows steering corrections to be made by rotation of the drill string to orientate the cutting head.

BLIND SHIELD

Non-mechanical shield which has a controlled and partly sealed face.

BORE

Void which is created to receive a pipe, conduit or cable.

CAN

Principal module which is part of a shield machine as in microtunnelling or of a TBM. Two or more may be used, depending on the installation dimensions required and the presence of an articulated joint to facilitate steering.

CARRIER PIPE

Pipe to be rehabilitated by any trenchless rehabilitation method.

CASED BORE

Bore in which a pipe, usually a steel sleeve, is inserted simultaneously with the boring operation. Usually associated with auger boring or pipe jacking.

CASING

Pipe to support a bore. Usually not a product pipe.

CASING PIPE METHOD

Method in which a casing, generally steel, is pipe jacked into place, within which a product pipe is later inserted.

CAULKING

General term which, in trenchless technology, refers to methods by which joints may be closed within a pipeline or between lining segments.

CCTV

Closed circuit television used to carry out internal inspection and survey of pipelines.

CHEMICAL GROUTING

Method for the treatment of the ground around a shaft or pipeline, using non-cementitious compounds, in order to facilitate or make possible the installation of an underground structure.

CHEMICAL STABILISATION

Renovation method in which a length of pipeline between two access points is sealed by the introduction of one or more compounds in solution into the pipe and surrounding ground and, where appropriate, producing a chemical reaction. Such systems may perform a variety of functions such as the sealing of cracks and cavities, the provision of a new wall surface with improved hydraulic characteristics or ground stabilisation.

CLOSE-FIT

See **LINING WITH CLOSE-FIT PIPES**

COMPRESSED AIR METHOD

General term which, in trenchless technology, refers to the use of compressed air within a tunnel or shaft in order to balance ground water pressure and to prevent ingress into an excavation open to the atmosphere.

CONTINUOUS SLIPLINING

See **LINING WITH CONTINUOUS PIPE**

CONVENTIONAL TRENCHING

Method in which access is gained by excavation from ground level to the required level underground for the installation, maintenance or inspection of a pipe, conduit or cable. The excavation is then backfilled and the surface reinstated.

CONVENTIONAL TUNNELLING

Method of tunnel construction ranging from manual excavation to the use of self-propelled tunnel boring machines. Where a lining is required, bolted segmental rings are frequently used.

CRUSH LINING

See **PIPE EATING**

CURED-IN-PLACE PIPE (CIPP)

See **LINING WITH CURED-IN-PLACE PIPES**

CUTTING/CUTTER HEAD

Tool or system of tools on a common support which excavates at the face of a bore. Usually applies to mechanical methods of excavation.

DIRECTIONAL DRILLING

Steerable method for the installation of pipes, conduits and cables in a shallow arc using a surface launched drilling rig. In particular, the term applies to large scale crossings in which a fluid filled pilot bore is drilled without rotating the drill string, and this is then enlarged by a washover pipe and back reamer to the size required for the product pipe. The required deviation during pilot boring is provided by the positioning of a bent sub

DISCRETE SLIPLINING

See **LINING WITH DISCRETE PIPES**

DRILL BIT/HEAD

Tool which cuts the ground at the head of a drill string, usually by mechanical means.

DRILL STRING/STEM

The total length of drill rods/pipe, bit, swivel joint etc. in a bore.

DRILLING FLUID/MUD

Mixture of water and, usually, bentonite or polymer continuously pumped to the cutting head or drill bit to facilitate the removal cuttings, stabilise the bore, cool the head and lubricate the passage of the product pipe. In suitable ground conditions water alone may be used.

DRIVE/ENTRY/SHAFT/PIT

Excavation from which trenchless technology equipment is launched for the installation or renovation of a pipeline, conduit or cable. It may incorporate a thrust wall to spread reaction loads to the ground.

DRY BORE

Method of creating a bore without the use of a drilling fluid. Usually associated with guided impact moling, but may also apply to some rotary methods.

EARTH PIERCING

Term commonly used in North America as an alternative to Impact Moling.

EARTH PRESSURE BALANCE (EPB) MACHINE

Type of microtunnelling machine in which mechanical pressure is applied to the material at the face and controlled to provide the correct counter-balance to earth pressure in order to prevent heave or subsidence. The term is usually employed where the pressure originates from the main jacking station in the drive shaft or to systems in which the primary counter-balance to the earth pressure is supplied by pressurised drilling fluid or slurry.

EARTH PRESSURE BALANCE (EPB) SHIELD

Mechanical tunnelling shield which utilises a full face to support the ground in front of the shield and usually employs an auger flight to extract the material in a controlled manner.

ENTRY/EXIT ANGLE

Angle to the ground surface at which the drill string enters or exits in forming the pilot bore in a directional drilling/guided drilling system.

EPB Abbreviation for Earth Pressure Balance.

EXPANDER

A tool which enlarges a pilot bore during a pull-back operation by compression of the surrounding ground rather than by excavation. Sometimes used during a thrusting process as well as during pull-back.

FACE STABILITY

Stability of the excavated face of a tunnel or pipe jack.

FERRO-CEMENT

Material comprising cementitious and steel elements to form a structural lining, which is either placed in situ in a man-entry size pipeline or tunnel, or is preformed into segments for later installation.

FLUID ASSISTED

Method of guided drilling using a combination of mechanical drilling and BORING/DRILLING pressurised fluid jets to provide the soil cutting action.

FLUID JET CUT

See JET CUTTING

FOLD & FORM LINING

Method of pipeline rehabilitation in which a liner is folded to reduce its size before insertion and reversion to its original shape by the application of pressure and/or heat.

FREE BORING

Method of auger boring without a casing.

GROUTING

Method of filling voids, usually with cementitious grout.

GUIDE RAIL

Device used to support or guide, first the shield and then the pipe within the drive shaft during a pipe jacking operation.

GUIDED AUGER BORING

Method of auger boring in which the guidance mechanism actuator is sited in the drive shaft. The term may also be applied to those auger boring systems with rudimentary articulation of the casing near the cutting head activated by the rods from the drive shaft.

GUIDED BORING

See GUIDED DRILLING

GUIDED DRILLING

Method for the installation of pipes, conduits and cables using a surface-launched drilling rig. A pilot bore is drilled using a rotating drill string and is then enlarged by a back reamer to the size required for the product pipe. The necessary deviation during the pilot boring is provided by a slanted face to the drill head, eccentric fluid jets or a combination of these, usually in conjunction with a locator.

HEAVING

Process in which the ground may be displaced causing a lifting of the ground surface.

HORIZONTAL DIRECTIONAL DRILLING (HDD)

See DIRECTIONAL DRILLING

IMPACT MOLING

Method of creating a bore using a pneumatic or hydraulic hammer within a casing, generally of torpedo shape. The term is usually associated with non-steered or limited steering devices without rigid attachment to the launch pit, relying upon the resistance of the ground for forward movement. During the operation the soil is displaced, not removed. An unsupported bore may be formed in suitable ground, or a pipe drawn in or pushed in behind the impact moling tool. Cables may also be drawn in.

IMPACT RAMMING

See PIPE RAMMING

IN LINE/ON LINE REPLACEMENT

See REPLACEMENT

INFILTRATION

Water from the surrounding ground which enters through defects in pipes or joints in a pipeline or through the lateral connections, manholes or inspection chambers.

INFILTRATION/INFLOW (I/I)

The total quantity of water from both infiltration and inflow without distinguishing the source.

INFLOW

Water discharged into a sewerage system and service connections from sources on the surface.

INTERJACK PIPES

Pipes specially designed for use with an intermediate jacking station.

INTERJACK STATION

See **INTERMEDIATE STATION JACKING (IJS)**

INTERMEDIATE JACKING METHOD

Pipe jacking method which redistributes the jacking force by the use of intermediate jacking stations.

INTERMEDIATE STATION JACKING (IJS)

A fabricated steel shield incorporating hydraulic jacks designed to operate between interjack pipes to provide incremental thrust or to redistribute thrust on long pipe jacking drives.

INTERNAL INSPECTION

Means of ascertaining the condition of pipelines, either by visual inspection for man-entry size or by the use of remote control instrumentation.

JACKING FORCE

Force applied to pipes in a pipe jacking operation.

JACKING PIPES

Pipes designed for use in a pipe jacking operation.

JACKING SHIELD

Fabricated steel cylinder from within which excavation is carried out, either manually or by mechanical means. Incorporated within the shield are facilities for controlling the line and level.

JET CUTTING

Guided boring method using pressurised fluid jets for soil cutting.

JOINT SEALING

Method in which an inflatable packer is inserted into a pipeline to span a leaking joint, resin or grout being injected until the joint is sealed and the packer then removed.

LAUNCH PIT

As for drive pit but more usually associated with launching an impact moling or similar tool.

LEAD PIPE

The leading pipe designed to fit the rear of a jacking shield and over which the trailing end of the shield is fitted.

LINING WITH CLOSE-FIT PIPES

Method of lining with a continuous pipe for which the cross section is reduced to facilitate installation, and reverted after installation to provide a close fit to the existing pipe.

LINING WITH CONTINUOUS PIPE

Method of lining with a pipe made continuous for the length of the section to be renovated prior to insertion, and which has not been shaped to give a cross sectional diameter smaller than its final diameter after installation.

LINING WITH CURED-IN-PLACE PIPES

Method of lining with a flexible tube impregnated with a thermosetting resin which produces a pipe after resin cure.

LINING WITH DISCRETE PIPES

Method of lining with pipes shorter than the section to be renovated which are not jointed prior to insertion to form a continuous pipe, and which have not been shaped to give them a cross sectional diameter smaller than their final diameter after installation.

LINING WITH INSERTED HOSE

Method of lining with a loose fit reinforced hose to provide a pipe lining such that fluids may be conveyed under pressure.

LINING WITH PIPE SEGMENTS

Method of lining with pipe sections made of at least two pieces with both longitudinal and circumferential joints.

LINING WITH SPIRALLY WOUND PIPES

Method of lining with a profiled strip, spirally wound to form a continuous pipe after installation.

LIVE INSERTION

Method of installation of a liner whilst the product pipe remains in service.

LOCALISED REPAIR

Repair work on a pipe, particularly sewerage, for lengths less than the run between two adjacent access points.

LOCATOR

An electronic instrument used to determine the position and strength of electro- magnetic signals emitted from a transmitter sonde in the pilot head of a boring system, in an impact moling tool or from existing underground services which have been energised. Sometimes referred to as a Walkover System.

LOW LOAD METHOD

A pipe jacking method in which separate provision is made to carry the jacking load, the pipe being installed carrying little or none of the jacking force.

LUBRICATION

Means of reducing friction either around a pipe being jacked or a shaft being sunk into the ground.

MAN-ENTRY

Description of any operation which requires an operative to enter a pipe, duct or bore. The minimum size and other conditions for which this is permissible may be defined under health and safety legislation.

MANUAL MECHANICAL SHIELD

Open shield in which manpower is used to excavate the material but which has some steering capability.

MEASUREMENT WHILE DRILLING (MWD)

Instrumentation in a bore that provides continuous data simultaneously with drilling operations, usually transmitting to a display at or near the drilling rig.

MECHANICAL PROPS REPAIR
See **REROUNDING**

MICROTUNNELLING

Method of steerable remote control pipe jacking to install pipes of internal diameter less than that permissible for man-entry. In North America the term is used to describe remote control continuous pipe jacking in all diameters.

MIDI-RIG

Steerable surfaced launched drilling equipment for the installation of pipes, conduits and cables. Applied to intermediate sized drilling rigs used as either a small directional drilling machine or a large guided boring machine. Tracking of the drill string may be achieved by either a downhole survey tool or a locator.

MINI-HORIZONTAL DIRECTIONAL DRILLING

An alternative term for Guided Drilling.

MODIFIED SLIPLINING

See **LINING WITH CLOSE-FIT PIPES**

MOLE

See **IMPACT MOLING**

MOLE PLOUGHING

Method of installing a pipeline by pulling a plough through the ground whilst a continuous length of pipe is fed into the top of the plough whilst a continuous length of pipe is fed into the top of the plough and buried from the tail.

NARROW TRENCHING

Method of excavation of a trench up to 100mm wider than the outside diameter of the service to be installed, usually employing either a rockwheel or chain type trencher.

NOMINAL SIZE

Size of pipe or shaft used to define the internal working diameter.

NON-MAN ENTRY

Size of pipe, duct or bore less than that for man-entry.

OPEN CUT

See **CONVENTIONAL TRENCHING**

OPEN FACE SHIELD

Shield in which manual excavation is carried out from within a steel tube at the front of a pipe jack.

OVALITY

The difference between the maximum and minimum diameter divided by the mean diameter at any one cross section of a pipe, generally expressed as a percentage.

PILOT BORE

First, usually steerable, pass of any boring operation which later required back-reaming or other enlargement. Most commonly applied to guided drilling, directional drilling and 2-pass microtunnelling systems.

PIPE BURSTING

Replacement method in which an existing pipe is broken by brittle fracture, using mechanically applied force from within. The pipe fragments are forced into the surrounding ground. At the same time a new pipe, of the same or larger diameter, is drawn in.

PIPE DISPLACEMENT

Term used in North America.

PIPE EATING

Replacement method, usually based on microtunnelling, in which a defective pipe is excavated together with the surrounding ground and a new pipe installed. The microtunnelling shield machine will usually need some crushing capability. The defective pipe may be filled with grout to improve steering performance. Alternatively, a proboscis device to seal the pipe in front of the shield may be used.

PIPE JACKING

Method for directly installing pipes behind a shield machine by hydraulic or other jacking from a drive shaft such that the pipes form a continuous string in the ground.

PIPE PULLING

Method of replacing small diameter pipes where a new product pipe is attached to the existing pipe which is then pulled out of the ground.

PIPE RAMMING

Non-steerable method of forming a bore by driving a steel casing, usually open-ended, with a percussive hammer from a drive pit. The soil may be removed by augering, jetting or compressed air. In appropriate ground conditions a closed casing may be used.

PIPE SPLITTING

Replacement method for breaking an existing pipe by longitudinal slitting. At the same time a new pipe of the same or larger diameter may be drawn in behind the splitting tool.

PIPELINE SYSTEM

Interconnecting pipe network for the conveyance of fluids.

POINT SOURCE REPAIR

See LOCALISED REPAIR

POINTING

Method of repairing a brick sewer or manhole by the application of cement mortar where loss has occurred.

PRECONDITIONING WORK

That part of a project, usually before renovation work, which includes preparatory cleaning and internal inspection.

PREPARATORY CLEANING

Internal cleaning of pipelines, particularly sewers, prior to inspection, usually with water jetting and removal of material where appropriate.

PRODUCT PIPE

Permanent pipeline for operational use.

PULL-BACK

That part of a guided boring or directional drilling operation in which the drill string is pulled back through the bore to the entry pit or surface rig, usually installing the product pipe at the same time.

PULL-BACK FORCE

Tensile load applied to a drill string during pull-back. Guided boring and directional drilling rigs are generally rated by their maximum pull-back force.

RECEPTION/EXIT SHAFT/PIT

Excavation into which trenchless technology equipment is driven and may be recovered during the installation or renovation of a product pipe, conduit or cable.

REHABILITATION

All methods for restoring or upgrading the performance of an existing pipeline system.

REINSTATEMENT

Method of backfilling, compaction and re-surfacing of any excavation order to restore the surface and underlying structure to enable it to perform its original function.

RENOVATION

Methods of rehabilitation in which all or part of the original fabric of a pipeline is incorporated and its current performance improved.

REPAIR

Rectification of local damage.

REPLACEMENT

Methods of rehabilitation of an existing pipeline system by the installation of a new system, either on or off the existing line, without incorporating the original fabric.

REROUNDING

Preparatory operation in which an expansion device is inserted into a distorted pipe to return it to a circular cross section. It is usually carried out prior to the insertion of a permanent liner or supporting band.

RESIN INJECTION

Method used in the localised repair of pipes, usually sewers, by injection into cracks, defects or cavities of a resin formulation which subsequently cures to prevent leakage and further deterioration.

ROBOT

Remote control device with closed circuit television (CCTV) monitoring, used mainly in localised repair work, such as cutting away obstructions, re-opening lateral connections, grinding and re-filling defective areas and injecting resin into cracks and cavities.

ROD PUSHING

Method of forming a pilot bore by driving a closed pipe head with rigid attachment from a launch pit into the soil which is displaced. Limited steering and monitoring capability may be provided, usually in conjunction with a locator.

SEGMENTAL LINING

See LINING WITH PIPE SEGMENTS

SEGMENTAL SLIPLINING

See LINING WITH DISCRETE PIPES

SHIELD TUNNELLING METHOD

Method of excavation in the front of a tunnel or pipe jack using a shield.

SLEEVE PIPE

Pipe installed as external protection to a pro-duct pipe.

SLIME SHIELD

Earth pressure balance shield with soil conditioning additives to facilitate the excavation of the ground.

SLIPLINING

General term used to describe methods of lining with continuous pipes and lining with discrete pipes.

SLURRY SHIELD METHOD

Method using a mechanical tunnelling shield with closed face which employs hydraulic means for removing the excavated material and balances the ground water pressure.

SOFT LINING

See LINING WITH CURED-IN-PLACE PIPES

SPACER BLOCK

Device used to extend the distance that the hydraulic rams within a jacking system can propel the pipeline.

SPIRAL LINING

See LINING WITH SPIRALLY WOUND PIPES

SPRAY LINING

Method for applying a lining, usually of cement mortar or resin, by a rotating spray head which is winched through an existing pipeline.

SSES Sewer system evaluation survey of tributary sewer systems with levels of infiltration and inflow.

STABILISATION

See CHEMICAL STABILISATION

STANDARD DIMENSIONAL RATIO (SDR)

The ratio of minimum outside diameter of a pipe to wall thickness.

STEERABLE MOLING

Method similar to impact moling with a limited steering capability.

SUBSIDENCE

Process in which the ground may be displaced causing a settlement at the surface.

SURVEY TOOLS

Downhole equipment and instruments used to determine the position of a bore in directional drilling or in site investigation.

SWAGELINING

Method of lining with close-fit pipes in which a temporary reduction in diameter is achieved by passing it through one or more dies which may be heated. This is a Registered Trade Mark of BG plc.

TARGET SHAFT/PIT

See RECEPTION/EXIT SHAFT/PIT

THRUST

Force applied to a pipeline or drill string to propel it through the ground.

THRUST BORING

Unpreferred term, loosely applied to various trenchless installation methods. See Rod Pushing.

THRUST JACKING METHOD

Method in which a pipe is jacked through the ground without mechanical excavation of material from the front of the pipeline.

THRUST PIT

See DRIVE/ENTRY/SHAFT/PIT

THRUST RING

Load spreading device to transfer force from the hydraulic rams on to the pipeline in a pipe jacking operation.

TRENCHING

See CONVENTIONAL TRENCHING

TRENCHLESS TECHNOLOGY

Methods for utility and other line installation, rehabilitation, replacement, renovation, repair, inspection, location and leak detection, with minimum excavation from the ground surface.

TUNNEL BORING MACHINE (TBM)

A machine that excavates a tunnel by drilling out the face to full size in one operation. It may be controlled from within the shield or remotely.

UNCASED BORE

Self supporting bore without a lining or inserted pipe, whether temporary or permanent.

UPSIZING

Method in which the cross sectional area of an existing pipeline is increased by replacing it with a larger diameter pipe.

UTILITY CORRIDOR

Duct in which two or more different utility services are installed with access for maintenance. Also referred to as a Common Utility Tunnel, Common Duct or Utilidor.

WALKOVER SYSTEM

See LOCATOR

WASHOVER PIPE

Rotating drill pipe of larger diameter than the pilot drill and placed around it with its leading edge less far advanced. Its purpose is to provide stiffness to the drilling pipe in order to maintain steering control over long bores, to reduce friction between the drill string and the soil and to facilitate mud circulation. See Directional Drilling.

WATER JETTING

Method for the internal cleansing of pipelines using high pressure water jets.

Chapter 3 - Water pipelines

- Kursus i Vandforsyningsteknik XXXIII, Dansk Vandteknisk Forening, Århus University, 26 – 29 March 1984
- Bekendtgørelse af lov om afgift på ledningsført vand, no. 6756 of 13 July 1994 issued by the Danish Ministry of Taxation
- Vandforsyningsstatistik 1999, Danske Vandværkers Forening
- Project work under Vandteknisk Udvalg 1980: Lækageundersøgelse – vandtab og lækager på vandforsyningers ledningsnet

Chapter 5 - Tendering of NO-DIG projects

- Danske vandværkers Forening: Planlægning af vandledningers fornyelse. Vejledning nr 10 1995 CARE W: <http://>

Chapter 6 - Social costs - the environment

- PRISEK, Prioritering Samhällkonsekvenser Ekonomi, Bertil Gustafsson, Gilbert Svensson, VA-Forsk 1992-10
- Håndbog i miljørigtig projektering, BPS-centret, 1997
- Miljørigtig projektering af afløbssystemer, Nordisk Wavin, 1998
- Wirtschaftlichkeitsuntersuchungen bei Kanalsanierungen, Georg Grunwald, Ruhr Universität, 1997
- Nytte-kostnadsanalyser, Prinsipper for lønnsomhedsvurderinger i offentlig sektor, Norges offentlige utredninger, NOU 1997: 27
- Indirect Costs of Utility Placement and Repair Beneath Streets, Minnesota Department of Transportation, 1994
- Miljøvurdering af afløbsrør i PVC, PE, PP og Beton, Nordisk Plastrørsgruppe, 1997
- Hur tolkas en LCA-rapport? Göran Svensson, VA-Forsk 1998-17

Chapter 7 - Cleaning pipelines

- Rensning af afløbssystemer, Rørcenter-anvisning 006, autumn 2001
- Kursushandbok – SESC, BL Consult, Sweden
- Bekendtgørelse om kloakarbejde m.v., no. 473 of 7 October 1983 issued by The Danish Working Environment Service, "Bekendtgørelse om kloakarbejde m.v."
- Bekendtgørelse om ændring af bekendtgørelse om kloakarbejde m.v., no. 9 of 14 January 1988 issued by the Danish Working Environment Service
- At-meddelelse "Arbejde med højtryksrensning", no. 4.04.18 of Oktober 1990

- DS 432:2000 "Norm for afløbssystemer" issued by The Society of Danish Engineers

Chapter 8 - Cured-in-place lining

- Meddelande VAV M61, Svenska vatten- och avloppsverksföreningen, Dec. 1987
- Anlægsteknik, Polyteknisk Forlag, 2001
- Renovering af afløbsledninger, Svenska vatten- och avloppsverksföreningen, Sept. 1989, VAV P66
- Servisavloppsledningar – erfarenheter och råd vid schaktfri renovering, VAFORS-report 1999:20
- Focus på stik, Per Aarsleff A/S, May 1999

Chapter 9 - Sliplining

- Design and Installation of Buried Plastic Pipes, by Lars-Eric Janson and Jan Molin.
- Sewerage Rehabilitation Manual, Water Research Centre.
- Pipe-manufacturers' product guides.
- Renovering af afløbsledninger - retningslinier for valg, dimensionering og udførelse, Danish Technological Institute, 1989.
- Renovering af vandledninger – retningslinier for valg, dimensionering og udførelse, Danish Technological Institute, 1995.

Chapter 19 - Control schemes

www.nodig-kontrol.dk

- Control committees of Danish control schemes – 2001
- Control Scheme for Danish CCTV Inspection Companies (DTVK)

DTVK is managed by an independent control committee with the following members:

- Per Jacobsen, Københavns Energi (appointed by the Association of Local Authority Technical Directors)
- Nis Buchardt, NIRAS (appointed by the Danish Association of Consulting Engineers)
- Inge Faldager, Danish Technological Institute
- Jens Lystbæk & Arvid Andersen, Danish

Contractors' Association, CCTV inspection group

The following two technical consultants are affiliated to DTVK:

- Allan Møller, Københavns Energi
- Erik Andersen, Brande municipal authority.

Control Scheme for Pipeline Rehabilitation

The control scheme is managed by an independent control committee with the following members:

- Gerda Hald, Odense Vandselskab as (appointed by DANAS – until March 2002)
- Christian Lerche, Kalundborg Kommune (appointed by DANAS – from March 2002)
- Flemming Koldborg Jensen, Roskilde Kommune (appointed by Association of Local Authority Technical Directors)
- Morten Steen Sørensen, NIRAS (appointed by FRI)

The extended control committee also has the following two company representatives:

- Lars Gaarn Jensen, Per Aarsleff A/S
- Bent Rasmussen, Inpipe Danmark A/S

In addition, the following two technical consultants are affiliated to the control scheme:

- Per Romdal, Danish Technological Institute
- Flemming Springborg, Danish Technological Institute

Control Scheme for Directional Drilling and Pipe Jacking

The control scheme is managed by an independent control committee with the following members:

- Gunnar Hansen, Kolding Kommune (appointed by DANAS)
- Mogens Ditlev, Naturgas Midt-Nord (appointed by FULS)
- Henrik Vinther Jensen, Teledanmark (appointed by FULS)
- Jørgen Ølgaard, Ingeniørfirmaet Øllgaard (appointed by FRI)

The extended control committee also has the following four company representatives:

- Bent Hansen, Aagaard A/S, Vejle
- Karsten Haslund, Højgaard & Schultz A/S
- Rene Oppenhagen, Per Aarsleff A/S
- Michael Thomsen, NCC Danmark A/S

Agreement has recently been reached with Københavns Energi on affiliating technical consultants to the control scheme.

Methods of evaluating social costs

This section deals with what are today the most widespread methods of evaluating/calculating the effects of installations and selecting the installation techniques to be used when a pipeline owner wishes to minimise the effects and inconveniences caused by pipeline work.

- Present value calculations
The economics of individual effects and inconveniences are estimated to the extent possible
- Objective control
The objectives and requirements arising from what will be acceptable to the pipeline owner are set, together with the acceptable level of various effects and inconveniences
- Pricing traffic disruptions and delays
Calculations are made, for example, on the basis of traffic surveys and other factors to determine a figure for “loss of earnings” to be used in weighting methods of installation
- Alternative forms of contract
A figure is calculated to cover the fees necessary for the right to use installation site areas. Different calculation principles can be used

Various methods of estimating the effects of air pollution and noise will also be covered.

Present value calculations

Present value calculations include the calculation of the sum of all capitalised effects/ inconveniences. In the calculations, an interest rate is estimated (often fixed in the individual country) and all future payments are discounted to present values.

Other assumed conditions:

- All types of costs can be included in the calculation for the entire cost accounting period
- All types of costs are comparable, in that the estimated interest rate is used in discounting to the same point in time, i.e. 0 (the present)
- All costs can be added to give a total estimated cost (“life cycle cost”)

- An investment in year 0 implies that the present value of the capital cost = the investment cost
- Operating and maintenance costs during the whole cost accounting period are discounted to present value
- All other effects/inconveniences (e.g. all social costs) are also discounted to present value

The method is a general one in which the comparison of different methods of installation is based on the calculated present values involved in each individual method.

Calculation factors:

- Investment costs - original cost of plant
- Residual value - expected value of plant at end of cost accounting period
- Re-investment - original cost for renewal at end of cost accounting period
- Operating and maintenance costs - all costs for inspection, repair, etc. in cost accounting period
- Social costs - all effects/inconveniences valued for whole cost accounting period
See also VA-Forsk Report 1992-10: PRISEK (see references).

Present value calculations cover the individual social costs to the extent they can be capitalised.

Objective control

Objective control can be performed in several ways when delineating installation tasks, generally by the pipeline owner setting overall objectives and requirements which must always be observed. This is often supplemented by objectives and requirements specific to the actual task.

Furthermore, during the planning phase and prior to accepting a tender, the pipeline owner will have judged/evaluated alternatives/tenders using a “checklist” covering the conditions that he/she regards as essential.

Examples of questions that must be answered in connection with every alternative/tender:

- How large will involved areas be?
- What are the areas used for?
- How do pedestrians/cyclists/vehicle drivers get past the work sites?
- How are access conditions to dwellings?
- What diversions will be possible – and to what extent?
- How can work safety be maintained at the site?
- What quantities of earth, etc. will require removal/storage – and how far from the site?

The list is not exhaustive, but the answers to the above and perhaps other questions will illuminate the possible effects and inconveniences that such work might cause.

As with any kind of choosing between alternatives, the answers to each of the above questions can be awarded points.

It is in this way that the pipeline owner determines the extent to which inconveniences will arise from the different alternatives/tenders being considered.

The list of both general objectives and requirements and the more special conditions surrounding the individual project should always be known to contractors before they submit tenders.

With the help of these objectives and requirements, the pipeline owner is able to regulate the implementation of pipeline work.

In recent years, the use of objective control/setting objectives in these forms has become much more widespread in countries outside Denmark.

Objective control is involved in calculating all forms of social costs.

Pricing traffic disruptions and delays

When pricing traffic disruptions, the considerations are a) the quantity of traffic that will be affected by the installation work, b) the extent of these disruptions, and c) the possibilities that exist of avoiding passage across the site by setting up diversions.

There are a number of models for such pricing.

The simplest calculation consists of setting a cost based on XX per vehicle that passes the site.

An example of the hour prices which can be used when evaluating traffic delays is shown on the following page.

Pricing traffic disruptions and delays involves only part of the social costs in the area of traffic and transport.

Particularly in the USA, several cost-benefit models for traffic on major roads are also used.

Alternative forms of contract

In several countries, efforts are increasingly being made to cut down the duration of traffic disruption through the use of alternative forms of contract. Two are especially prominent: Cost-Plus-Time contracts and contracts based on the Lane Rental principle.

Cost-Plus-Time contracts

With Cost-Plus-Time contracts, contractors are invited to tender in two parts: A price for the work and a time for its implementation.

The price is the traditional quotation for all parts of the project.

The time is the number of calendar days allowed for the contractor to complete the work. The lowest and the best tender will be based on a combination of the price and a cost calculated on the basis of the time stated in the tender. The standard price for time is specified in the tendering documents sent out by the pipeline owner.

If the contractor completes the work before the due time, the pipeline owner pays a bonus. If on the other hand the contractor is late in completing the work, a penalty must be paid to the owner.

Lane-Rental contracts

Lane-Rental contracts include an area rental.

Such rental can be based on the size, shape and position of the work site. It also includes a standard price depending on the disruption that occurs at different parts of the area. For example, the rental is different for road areas, turning spaces, pedestrian pavements, green areas, etc.

The rent is based on the actual time the different parts of the project take and can vary according to the time of day involved (high rent for rush hours, low rent for night hours). The lowest and best tender will be based on the overall lowest price. The rental is deducted from each instalment paid under the contract.

Assessment of travelling time

In 1995, the Norwegian Public Roads Administration revised the time values it used in pricing time for consequence analysis.

This table applies to “light vehicles” and gives prices in Norwegian kroner at the 1995 price level:

Purpose of travel	NK/hour for car	NK/hour for person
Travel during working hours	198	146
To and from work	65	46
Other travel	65	31

Travel during working hours covers salaries, employers’ contribution, and social costs.

For “heavy vehicles” exclusive buses, time costs cover salaries including social costs for the driver and any co-driver, an amount for administration, capital costs, and garaging.

“Heavy vehicle” costs are in Norwegian kroner at the 1995 price level:

Vehicle type	NK/hour
Commercial vehicle	260
Heavy goods vehicle	319

With respect to waiting time, the costs are set at double the time spent in the vehicle. Time spent waiting for ferries and buses is mentioned specifically in this context. Traffic disruption because of road works is not referred to directly.

Examples can be seen in England where up to 35% savings on traffic delays have resulted from this form of contract.

Because they reduce the consumption of time, these alternative forms of contract indirectly affect all social costs. Lane-Rental contracts have a more direct influence on most forms of traffic disruption and commercial and residential inconvenience, in that area rentals can be regulated. The methods described are most used in the interests of traffic.

Trade

Statistics are available from Bremen, Germany, for turnover in various types of retail outlets. A selection of the various types is shown in the following. Turnover is shown per unit shop area and per employee. Most data are only available per unit area. Index 1993.

Sector	Turnover DM/m ²	Turnover DM/employee
Textiles, clothing, shoes	4.580	165.000
Food, drink, tobacco	7.050	215.000
Stationary, office machines	7.320	168.000
Chemists	9.040	223.000

There are also examples from Germany in which the reduction in turnover is a function of the type of traffic disruption – the table below shows empirical values for the relative reduction in turnover depending on conditions:

Sector	Restricted pavement	Restricted parking	Blockage of one lane	Blockage of two lanes
Textiles, clothing, shoes	10	10	20	40
Food, drink, tobacco	10	10	20	40
Stationary, office machines	10	10	20	40
Petrol stations	0	0	30	80
Hotels and restaurants	20	30	30	70

The data shown above should be treated with caution as they have been taken out of their true context in order to provide examples of pricing social costs.

Traffic disruption

The following simple model is used in the UK to calculate extra costs for vehicles, including the cost of time lost:

$$\text{Total costs} = \text{NVD} \times (\text{VOC} \times \text{EDD} + \text{TC} \times \text{EDT}) \times \text{IT}$$

- NVD = Number of vehicles per day
- VOC = Vehicle operating cost
- EDD = Extra driving distance
- TC = Cost per vehicle per hour
- EDT = Extra driving time
- IT = Installation time

There are several preconditions with regard to when a road is deemed closed (< 3 m lane for traffic) and when two lanes may be used (> 5.5 m), etc.

The model was developed by UMIST (Manchester University).

Much basic data is currently available in Germany on passenger cars, lorries and buses (see Emissions to the atmosphere on page 7). There are also models for calculating extra driving time as a result of traffic jams at construction sites, vehicle operating costs, personnel costs, etc.

Methods of life cycle assessment and environmentally friendly design

In this section, some of the principles of life cycle assessment and environmentally friendly design will be discussed in more detail. Specific examples of evaluating various environmental impacts will also be shown.

Life cycle assessment

As previously mentioned life cycle assessment is a tool for carrying out complete environmental evaluations of products, goods, methods, etc. throughout their entire life cycle from "cradle" to "grave".

While life cycle assessment cannot provide pre-packaged solutions and ready-made decisions, it can be used to improve the basis on which decisions are made together with the (private or public) company's environmental objectives.

In other words, the result of a life cycle assessment is not always a YES or NO. The results show or indicate the most significant aspects with regard to environmental impacts.

The methods used in life cycle assessments are therefore crucial, and it is always important to know which methods were used when the results of a life cycle assessment are to be utilised.

Most life cycle assessments consist of the following:

- Determination of the purpose of the assessment
- Definition and delimitation of the product – this must be done for all five phases in the life cycle so that the assessment is well-defined
- Definition and delimitation of the way in which environmental impacts are to be determined – including the choice of data sources
- Assessment of all environmental impacts, including assessment and weighting of all the effects and consequences of environmental impacts. It is in this respect that several of the models mentioned at the end of this chapter differ
- The final step in some, but far from all, life cycle assessments is a sensitivity analysis, which shows the extent to which fluctuations in the various data for environmental impacts affect the overall assessment

Several assumptions are made, especially in the three first parts of the assessment – purpose, delimitation and determination. Also in this respect, it is important to have well-defined environmental objectives because they provide a sound basis on which to base the assumptions necessary for the assessment.

Several questions, which must be answered in connection with the first three parts of the life cycle assessment, are given below:

- What will the assessment be used for?
- Which decisions will be made on the basis of the assessment?
- What are the consequences of these decisions?
- What comprises the product to be assessed?
- Which technical (and economic) requirements must the products meet?
- What is the extent of the individual life cycle phases in the specific project? What are their boundaries with the "outside surroundings".
- Which data sources are applicable? Are they sufficiently detailed?
- How are the impacts and effects in the various life cycle phases to be weighted in relation to one another?

When considering a life cycle analysis, it is important to be aware of how the assessment was performed – that certain assumptions have been made, that assessment models are often subjective, that conditions may vary locally, etc. Such limitations should always be made clear in any serious life cycle assessment, and should be stated when publishing its results or using them in any other way.

The following methods/models from various universities and institutions are among the most commonly used in Europe today:

- Effect category method, Chalmers Industriteknik, Sweden
- EPS Enviro-Accounting Method, Swedish Environmental Research Institute (IVL), Sweden.
- UMIP-Udvikling af Miljøvenlige Industri Produkter (Development of Environmentally Friendly Industrial Products), Institute for Product Development, Technical University of Denmark
- Eco-point, Switzerland
- Environmental Life Cycle Assessment of Products, the Netherlands
- Eco-indicator, the Netherlands

The UMIP method has proved to be very systematic and very applicable. Among other things, this is the only model to include the work environment to any great extent in the assessment. Assessment of the various environmental impacts in the UMIP method is to a certain extent based on political assessments, which can give rise to both short-term product assessments and geographically limited assessments.

A more detailed description of individual methods is beyond the scope of this handbook.

Environmentally friendly design

As previously mentioned, life cycle assessments and environmentally friendly design are two sides of the same coin.

In most cases, it makes no difference that life cycle assessment is concerned with products while environmentally friendly design is concerned with the entire system. Both consider effects from cradle to grave.

The main difference is that manufacturers or their trade associations often perform life cycle assessments to show how (little) their products affect the environment.

In contrast, the environmentally friendly design of, for example, construction work, entails the deliberate surveying, assessing and prioritising of materials and construction methods throughout all stages of the planning process, from initial planning to detailed design. Environmentally friendly design thus ensures that the overall environmental impacts and effects of the work are as few and small as possible, in accordance with established environmental objectives.

To a great extent, this is "merely" an ordinary, thorough planning and design process, which at all times takes environmental considerations into account.

Various tools are available for carrying out the work of normal project planning.

Among the tools used in environmentally friendly design are:

- Environmental plan with environmental objectives, environmental status and co-operation between the parties involved in the project
- Environmental survey of conditions in the field and environmental impacts of the materials, products and construction methods that are expected to be used
- Environmental programme and environmental management, in which technical information, environmental data, etc. are obtained and solutions causing unacceptable environmental impacts rejected
- Environmental investigations that include assessment of particularly polluting conditions, groundwater lowering, air pollution, noise pollution, recipient pollution, etc.

These tools are described in general terms for all aspects of construction work in Handbook on Environmentally Friendly Design (Håndbog i miljørigtig projektering), published in 1997 (see references).

Emissions to the atmosphere

Emissions to the atmosphere from vehicles is an important parameter in the assessment of construction work.

The following overview of harmful substances is from the German Ministry of Transportation. The values, which are expressed in g/kg fuel consumption, are typical for cars, buses and lorries.

Vehicle	CO	CH	NOx	SO ₂	Dust	CO ₂
Car	62,2	24,5	5,7	0,9	0,7	3026
Bus	26,2	19,6	65,1	2,0	1,2	3153
Lorry	24,7	12,2	55,7	2,2	0,7	3153

The emission of harmful compounds from vehicles is assessed as a total of all substances. Here, the compounds are weighted in relation to their toxicity, in which A applies to health and B vegetation.

A	1	500	200	100	100	-
B	1	500	333	125	100	-

Noise

There are several models for calculating noise.

Noise assessment in connection with construction work has been used in a number of cases in Germany. Both the noise from the construction site itself and the extra noise resulting from traffic jams, etc. should be assessed.

Among other things, assessments have been made for different parts of towns (distance from street to buildings, building use, number of storeys in the buildings, number of residents per km², etc.) and for different types of street.

For workplaces, assessments of various types of equipment (compressors, compactors, etc) are available.

